

STORAGE SYSTEMS

# PLASTIC *line*

STAMPAGGIO MATERIE PLASTICHE

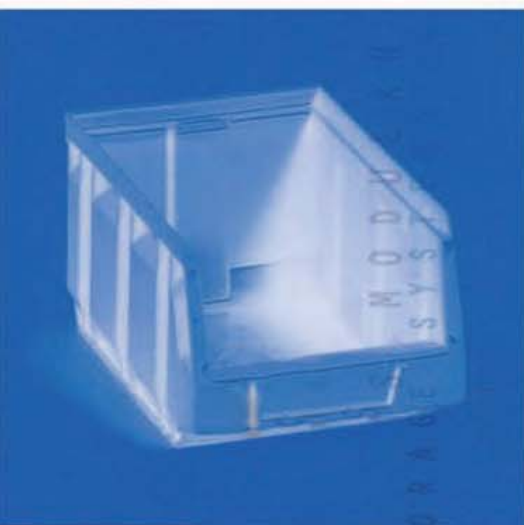

TERMS UNLOAD RULAR



**METALSISTEM**  
SISTEMI E STRUTTURE PER IL MAGAZZINO





CONTENITORI COMPONENTIBILI

## Linea "Block"

- Contenitori industriali a bocca di lupo **assemblabili** con incastro facile e sicuro e fortemente strutturati
- Impugnatura ergonomica anteriore e posteriore
- Porta etichette integrato nel frontale
- Prodotti in resina termoplastica antiurto
- Più prestazioni rispetto ai contenitori solo sovrapponibili: sono infatti componibili fra loro grazie a un facile e sicuro sistema di assemblaggio ad incastro sulle pareti laterali
- Le misure 4 e 5 sono assemblabili su 3 lati e possono essere unite anche posteriormente
- Facile e sicura componibilità grazie alla semplicità delle guide a incastro
- Possibilità di realizzare molteplici combinazioni di assemblaggio migliorando l'utilizzo dello spazio in termini di versatilità e flessibilità di impiego
- Il sistema di assemblaggio permette la creazione di strutture autoportanti anche senza utilizzo di scaffalature

# CONTENITORI

## Linea "Block"

- GB** Bins made of PS SHOCKPROOF slotted together
- F** Bacs assemblables en PS ANTICHOOC
- D** Aufbaubare Behälter in bruchfestem PSAU - Kunststoff
- E** Contenedores superponibles y componibles de encaje en Poliestireno Antichoque

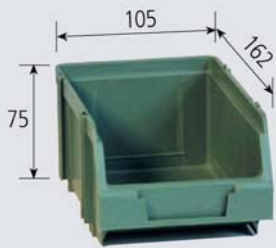

### BLOCK 2

#### Imballo da 48 pz.

Package of 48 pcs.  
Emballage de 48 pcs.  
Packung mit 48 St.  
Embalaje 48 un.



VERDE

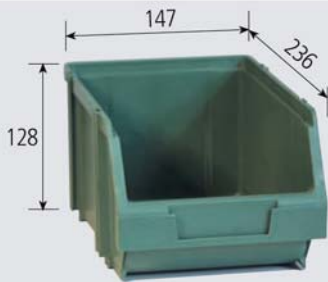

### BLOCK 3

#### Imballo da 38 pz.

Package of 38 pcs.  
Emballage de 38 pcs.  
Packung mit 38 St.  
Embalaje 38 un.



VERDE

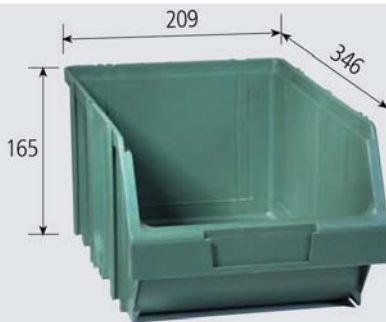

### BLOCK 4

#### Imballo da 24 pz.

Package of 24 pcs.  
Emballage de 24 pcs.  
Packung mit 24 St.  
Embalaje 24 un.



VERDE



### BLOCK 5

#### Imballo da 12 pz.

Package of 12 pcs.  
Emballage de 12 pcs.  
Packung mit 12 St.  
Embalaje 12 un.



VERDE

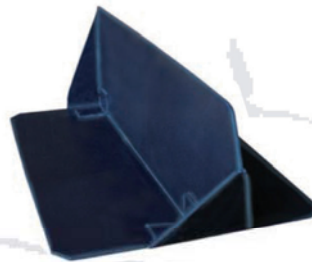

### SEPARATORI per BLOCK 5

#### Imballo a richiesta

Package on demand  
Emballage sur demande  
Packung auf Wunsch  
Embalaje a peticion



NERO



CONTENITORI



## Linea "Bull"

- Contenitori a bocca di lupo di struttura eccezionalmente robusta, sovrapponibilità facile e sicura, porta etichette integrato
- Prodotti con materiale plastico in grado di assicurare in ogni condizione climatica " da -40° a + 80°C" la massima resistenza agli urti, al carico, agli acidi, agli oli ed ai solventi
- Linea ergonomica con comoda impugnatura frontale e posteriore
- Fondo perfettamente piatto ed antisdruciuolo
- Dotati di bordo di aggancio posteriore per l'impiego pensile su pannelli
- Colori brillanti ed accurato design



# CONTENITORI

## Linea "Bull"

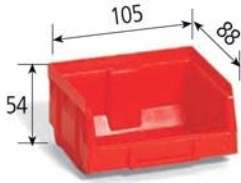

### BULL 1

**Imballo da 50 pz.**  
Package of 50 pcs.  
Emballage de 50 pcs.  
Packung mit 50 St.  
Embalaje 50 un.



VERDE GRIGIO ROSSO BLU GIALLO

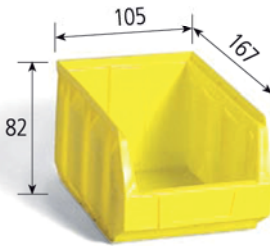

### BULL 2

**Imballo da 48 pz.**  
Package of 48 pcs.  
Emballage de 48 pcs.  
Packung mit 48 St.  
Embalaje 48 un.



VERDE GRIGIO ROSSO BLU GIALLO

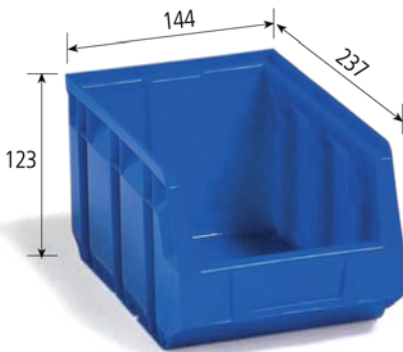

### BULL 3

**Imballo da 38 pz.**  
Package of 38 pcs.  
Emballage de 38 pcs.  
Packung mit 38 St.  
Embalaje 38 un.



VERDE GRIGIO ROSSO BLU GIALLO



### BULL 4

**Imballo da 24 pz.**  
Package of 24 pcs.  
Emballage de 24 pcs.  
Packung mit 24 St.  
Embalaje 24 un.



VERDE GRIGIO ROSSO BLU GIALLO

**GB** Open fronted bins with very strong structure. Easily to be placed one upon another. Large front label holder. Made of plastic material for use from  $-40^{\circ}$  to  $+80^{\circ}\text{C}$  guaranteed against fracture and breakage. Resistant to acids, oils, solvents and detergents. Ergonomic line with comfortable handles for lifting. Base completely flat and anti-skid. Full length return to clip to louvred panels. Brilliant colours and detailed design.

**F** Bacs à bec très robustes, gerbable en piles, avec porte étiquette frontal. Fabriqués en matière plastique haute résistance chimique aux huiles, graisses sels, acides ou détergents. Résistance mécanique apte pour usage intensif et durable. Résistance thermique en utilisation statique de  $-40^{\circ}$  a  $+80^{\circ}\text{C}$ . Ergonomiques avec large poignée de préhension à l'avant et à l'arrière. Fond parfaitement plat et antidérapant. Rebord de gerbage avec plots de blocage. Bord à l'arrière pour l'accrochage. Coloris brillants et design agréable.

**D** Äußerst widerstandsfähige, leicht und sicher aufzubauende Stapelbehälter mit integriertem Etikethalter. Hochwertiger Kunststoff steht für maximale Schlagfestigkeit, Beladbarkeit, Säure-, Öl- und Lösungsmittelbeständigkeit unter allen klimatischen Bedingungen von  $-40^{\circ}$  bis  $+80^{\circ}$ . Ergonomisches Design mit bequemem und praktischem Griff an der Vorder- und Rückseite. Völlig ebener, rutschfester Boden. Die Rückwand ist zur Befestigung als Hängebehälter an den Rahmen gestaltet. Leuchtende Farben und perfekt gestaltetes Design.

**E** Cajas de plástico apilables con abertura frontal. Estructura particularmente robusta, porta etiqueta integrado. Fabricados en material plástico con grande resistencia termica desde  $-40^{\circ}$  hasta  $+80^{\circ}\text{C}$  y grande resistencia mecanica al impacto y cargamento. Permanencia inalterable frente a grasas, aceites, disolventes y acidos. Línea ergonomica con comoda empuñadura frontal y posterior. Base perfectamente plana y anti deslizable. Posibilidad de uso pensil con soportes metalicos. Colores brillantes y agradable design.

# CONTENITORI



## BULL 4/D

Attrezzabile con 1, 2  
o 3 separatori mobili

Imballo da 8 pz.  
Package of 8 pcs.  
Emballage de 8 pcs.  
Packung mit 8 St.  
Embalaje 8 un.



VERDE GRIGIO ROSSO BLU GIALLO



## BULL 5

Imballo da 12 pz.  
Package of 12 pcs.  
Emballage de 12 pcs.  
Packung mit 12 St.  
Embalaje 12 un.

VERDE GRIGIO ROSSO BLU GIALLO

## SEPARATORI per BULL 5

Imballo a richiesta  
Package on demand  
Emballage sur demande  
Packung auf Wunsch  
Embalaje a peticion



NERO

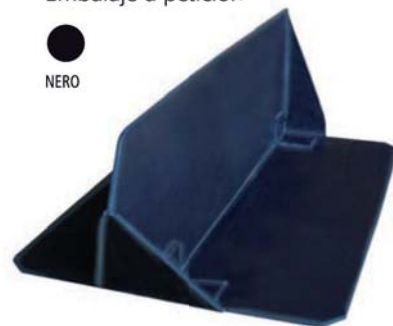

## Componibili BULL 6

Imballo da 4 pz.  
Package of 4 pcs.  
Emballage de 4 pcs.  
Packung mit 4 St.  
Embalaje 4 un.

VERDE

## Componibili BULL 6/D

Imballo da 4 pz.  
Package of 4 pcs.  
Emballage de 4 pcs.  
Packung mit 4 St.  
Embalaje 4 un.

VERDE



# CONTENITORI



## Componibili BULL 7

**Imballo da 4 pz.**  
 Package of 4 pcs.  
 Emballage de 4 pcs.  
 Packung mit 4 St.  
 Embalaje 4 un.

●  
VERDE

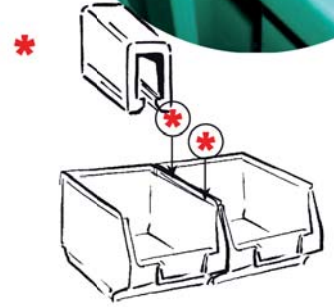
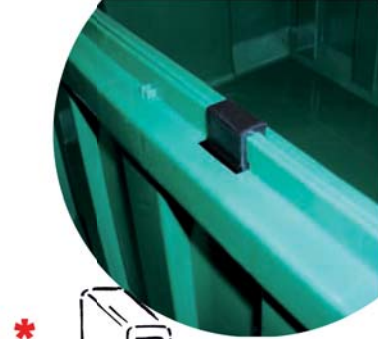

\* elemento di connessione orizzontale (solo per BULL 6 - 6/D - 7 - 7/D)



## Componibili BULL 7/D

**Imballo da 4 pz.**  
 Package of 4 pcs.  
 Emballage de 4 pcs.  
 Packung mit 4 St.  
 Embalaje 4 un.

●  
VERDE

## RESISTENZA AL CARICO PER IMPILAGGIO CONTENITORI serie BULL

### LOAD CAPACITY LIMIT FOR STACKED BOXES

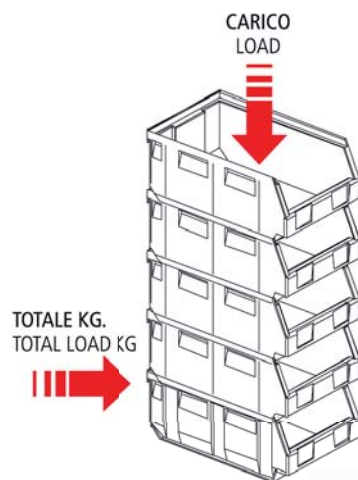

Tipo Item	Contenitori impilati Qty. of stacked boxes	Totale altezza mm. Total Height mm.	KG. Totali sul contenitore alla base Total load on the lowest box
<b>BULL 3</b>	9	1107	64
<b>BULL 4</b>	8	1312	105
<b>BULL 5</b>	7	1323	168
<b>BULL 6</b>	5	1250	120
<b>BULL 7</b>	4	1200	96



# CARRELLI

## Carrello monofronte

Art. n° 00005598

L. 720mm x P.390mm x H 1210mm

- con 6 livelli d'aggancio in altezza, monofronte
- with 6 single sided supports to locate plastic bins
- mit 6 Einhängprofilen für Kunststoff-Sichtlagerkästen
- avec 6 niveaux single-face pour accrocher des bacs



**I** Agili, pratici e robusti carrelli portacontenitori in lamiera verniciata a polvere, colore standard rosso RAL 3000. Dotati di n° 4 ruote gommata piroettanti di cui le due ruote anteriori provisti di freno. Predisposti per l'aggancio di contenitori BULL-1 fino a BULL-3. I carrelli vengono forniti premontati, in comoda confezione da kit. La confezione non contiene i contenitori in plastica che vanno ordinati a parte.

**GB** Very light, yet strong, steel trolleys for plastic bins. Powder coated in standard colour red, RAL 3000. Equipped with 4 rubber rimmed swivelling castor wheels, two with brakes. Designed to accommodate plastic bins. The trolleys are supplied preassembled, in kit form. The kit does not contain the plastic bins; these have to be ordered separately.

**F** Chariots solides à équiper avec des bacs en plastique. Les chariots sont produits en tôle peinte, RAL 3000. Avec 4 roues pivotants, dont 2 avec frein. Les chariots sont conçus pour l'agencement avec les bacs plastiques. Les chariots sont fournis prémontés, en kit. Le kit ne contient pas les bacs, ceux-ci sont à commander séparément.

## Carrello bifronte

Art. n° 00005179

L.1120mm x P.500mm x H.1240mm

- con 7+7 livelli d'aggancio in altezza, bifronte
- with 7+7 double sided supports to locate plastic bins
- mit 7+7 doppelseitigen Einhängprofilen für Kunststoff-Sichtlagerkästen
- avec 7+7 niveaux double-face pour accrocher des bacs



**D** Praktischer, robuster Werkstattwagen für Kunststoff-Sichtlagerkästen. Aus pulverbeschichtetem Stahl. Standardfarbe rot, RAL 3000. Mit 4 drehbaren Gummirädern, davon zwei mit Bremse. Ausgelegt zur Bestückung mit Kunststoff-Sichtlagerkästen. Die Wagen werden vormontiert geliefert, als KIT verpackt. Die Kunststoffkästen sind nicht im Kit enthalten und sind separat zu bestellen.

**E** Robusto y solido carro en chapa de acero para cajas "BULL", pintada con polvos epoxídicos RAL 3000. Dotado de 4 ruedas de goma pivotantes de las cuales 2 con freno. A petición disponible set standard de cajas.

# PANNELLI pensili



## V/690

### Pannello pensile

#### Imballo da 2 pz.

Package of 2 pcs.  
Emballage de 2 pcs.  
Packung mit 2 St.  
Embalaje 2 un.

*Esempio di pannello pensile completo di contenitori BULL*

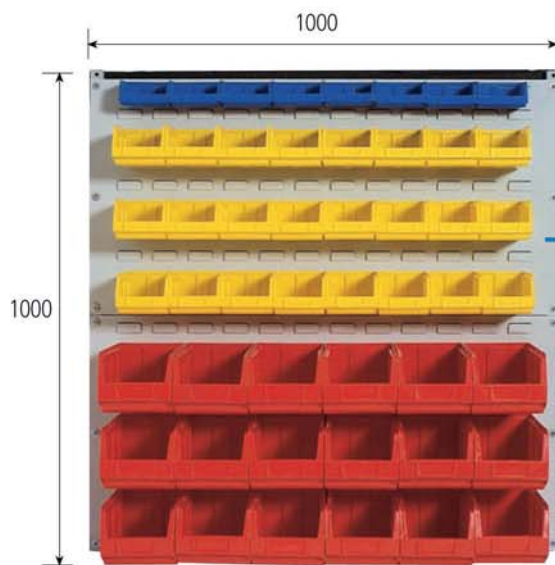

## V/6100

### Pannello pensile doppio

#### Imballo da 1 pz.

Package of 1 pcs.  
Emballage de 1 pcs.  
Packung mit 1 St.  
Embalaje 1 un.

*Esempio di pannello pensile completo di contenitori BULL*

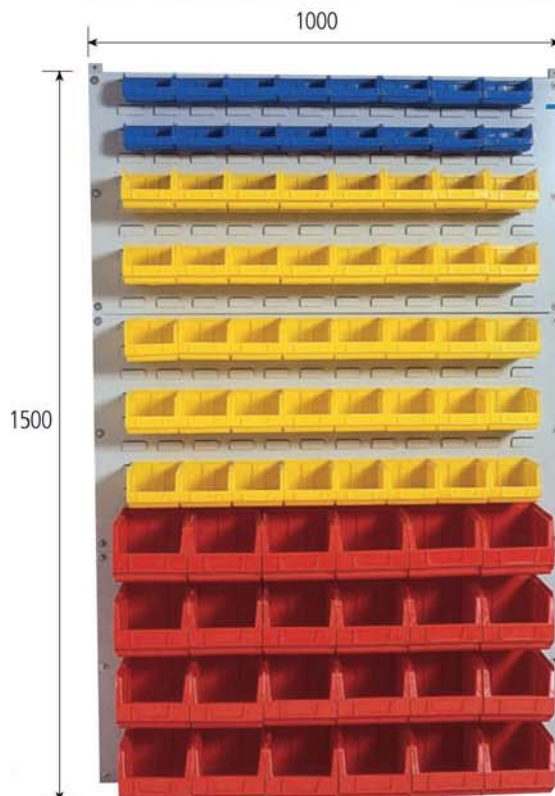

## V/6150

### Pannello pensile triplo

#### Imballo da 1 pz.

Package of 1 pcs.  
Emballage de 1 pcs.  
Packung mit 1 St.  
Embalaje 1 un.

*Esempio di pannello pensile completo di contenitori BULL*



- I Pratici pannelli pensili per contenitori "BULL", in lamiera verniciata con resina epossidica grigio RAL 5012.
- GB Louvered wall mounted steel panels for "BULL" plastic bins, powder coated grey RAL 5012.
- F Panneaux métalliques suspendus pour bacs «BULL», en tôle peinte avec poudre époxyde gris RAL 5012.
- D Gelochtes Wandpaneel aus Stahlblech, für „BULL“ Kunststoff-Sichtlagerkästen, Pulverbeschichtet, grau, RAL 5012.
- E Panel porta contenedores "BULL" en chapa, pintados con polvos epoxidicos Gris RAL 5012.

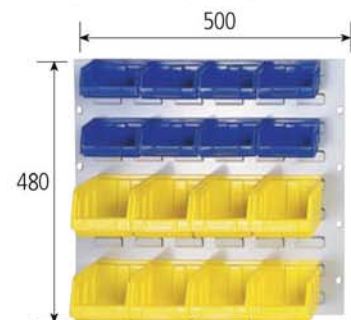

## V/645

### Pannello pensile

#### Imballo da 2 pz.

Package of 2 pcs.  
Emballage de 2 pcs.  
Packung mit 2 St.  
Embalaje 2 un.

*Esempio di pannello pensile completo di contenitori BULL*



## V/970

### Barra pensile

#### Imballo a richiesta

Package on demand  
Emballage sur demande  
Packung auf Wunsch  
Embalaje a peticion



# PANNELLI pensili

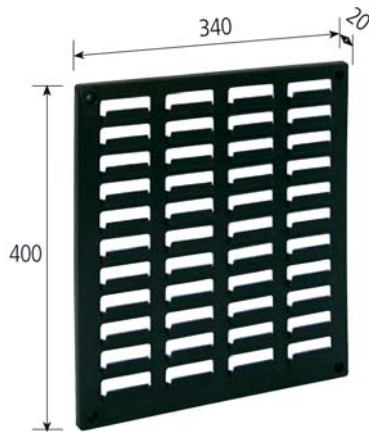

## V/640

### Pannello vuoto

#### Imballo a richiesta

Package on demand  
Embalage sur demande  
Packung auf Wunsch  
Embalaje a peticion



NERO

- I Pannello pensile in plastica per contenitori "BULL".
- GB Louvered wall mounted plastic panels for «BULL» plastic bins.
- F Panneau suspendu en plastique pour bacs «BULL».
- D Gelochtes Plastikpareel zur Aufhängung an der Wand, für „BULL“ Kunststoff-Lagersichtkästen.
- E Panel plastico para cajas "BULL".

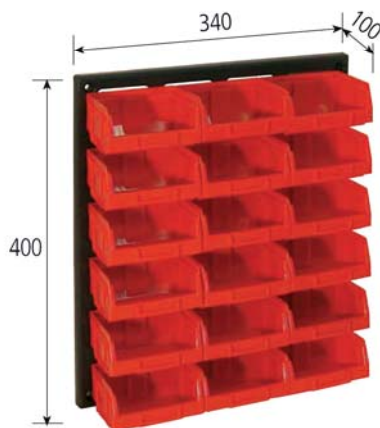

## V/640-1

### Pannello completo di:

-n. 18 Bull 1

#### Imballo a richiesta

Package on demand  
Embalage sur demande  
Packung auf Wunsch  
Embalaje a peticion



VERDE GRIGIO ROSSO BLU GIALLO

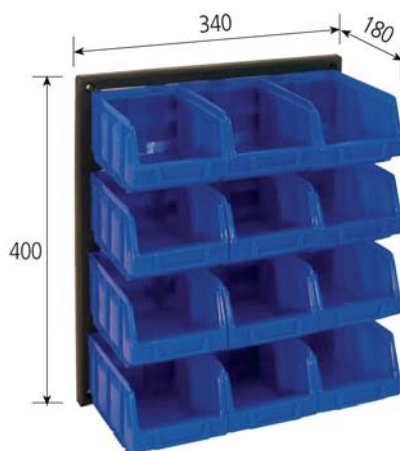

## V/640-2

### Pannello completo di:

-n. 12 Bull 2

#### Imballo a richiesta

Package on demand  
Embalage sur demande  
Packung auf Wunsch  
Embalaje a peticion



VERDE GRIGIO ROSSO BLU GIALLO

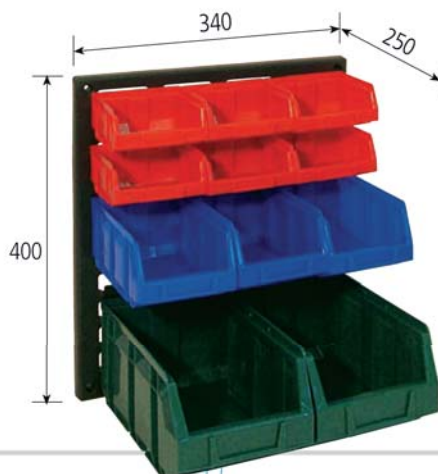

## V/640-M

### Pannello completo di:

-n. 6 Bull 1

-n.3 Bull 2

-n. 2 Bull 3

#### Imballo a richiesta

Package on demand  
Embalage sur demande  
Packung auf Wunsch  
Embalaje a peticion



VERDE GRIGIO ROSSO BLU GIALLO

# ASTINA pensile



## V/940

### Astina vuota

#### Imballo a richiesta

Package on demand  
Emballage sur demande  
Packung auf Wunsch  
Embalaje a peticion



NERO

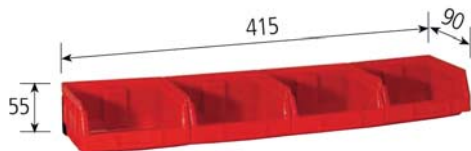

## V/940-1

### Astina completa di:

#### -n. 4 Bull 1

#### Imballo a richiesta

Package on demand  
Emballage sur demande  
Packung auf Wunsch  
Embalaje a peticion



VERDE GRIGIO ROSSO BLU GIALLO

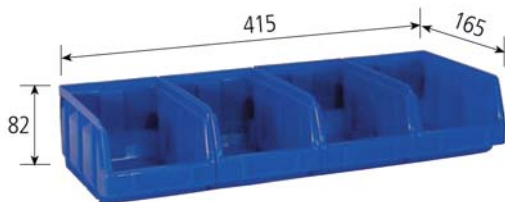

## V/940-2

### Astina completa di:

#### -n. 4 Bull 2

#### Imballo a richiesta

Package on demand  
Emballage sur demande  
Packung auf Wunsch  
Embalaje a peticion



VERDE GRIGIO ROSSO BLU GIALLO



## V/940-3

### Astina completa di:

#### -n. 3 Bull 3

#### Imballo a richiesta

Package on demand  
Emballage sur demande  
Packung auf Wunsch  
Embalaje a peticion



VERDE GRIGIO ROSSO BLU GIALLO

- I Set pensile in termoconfezione con astina e contenitori "BULL".
- GB Set of "BULL" plastic bins, shrink-wrapped, complete with hanging rod.
- F Set suspendu, emballé avec du film; le set est complet de bâtonnet plastique et de bacs «BULL».
- D Hängeset, bestehend aus Längsprofil und „BULL“ Kunststoff-Lagersichtkästen, in Schrumpffolie verpackt.
- E Set termoconfeccionado consistente con astina plastica y cajas "BULL".

CONTENITORI

# Linea Europallettizzabili

- 1 • Contenitori sovrapponibili in PEHD dotati di pareti piene e fondo liscio. Particolarmente indicati per essere impiegati in tutti i settori industriali e commerciali. Inattaccabili da acidi, oli e solventi. Dimensionati per l'uso ottimale dell'Euro pallet 1200 x 800.



## E4312

**Capacità 11 Lt.**  
**Imballo a richiesta**

Package on demand  
Emballage sur demande  
Packung auf Wunsch  
Embalaje a peticion



GRIGIO



## E4317

**Capacità 16 Lt.**  
**Imballo a richiesta**

Package on demand  
Emballage sur demande  
Packung auf Wunsch  
Embalaje a peticion



GRIGIO

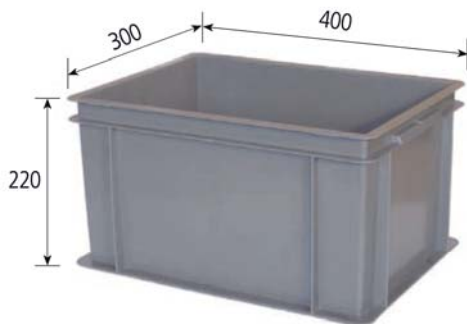

## E4322

**Capacità 21 Lt.**  
**Imballo a richiesta**

Package on demand  
Emballage sur demande  
Packung auf Wunsch  
Embalaje a peticion



GRIGIO

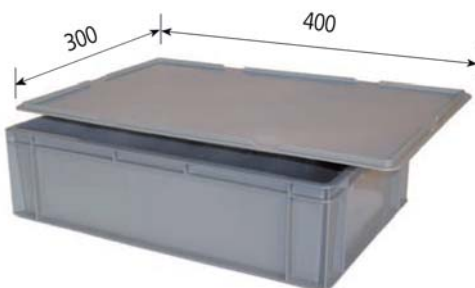

## E4300

**Coperchio per  
contenitori E4312 -  
E4317 - E4322**

**Imballo a richiesta**

Package on demand  
Emballage sur demande  
Packung auf Wunsch  
Embalaje a peticion



GRIGIO

# CONTENITORI Sovrapponibili Serie EURO 400 X 300

- GB** Stackable PEHD containers. With full thickness walls and smooth bottom. Suitable for all industrial and commercial purposes. Acid, oil and solvent-proof. Modular design to suit 1200 x 800 Europallet standard.
- F** Conteneurs superposables en PEHD à parois pleines et fond lisse. Particulièrement appropriés pour l'emploi dans tous les secteurs industriels et commerciaux. Inattaquables par les acides, les huiles et les solvants. Dimensionnés pour un emploi optimal de l'Euro-palette 1200 x 800.
- D** Aufstapelbare Behälter aus PEHD, vollwandig und mit glattem Boden. Besonders für den Einsatz in allen Industrie- und Handelszweigen geeignet. Säure-, Öl- und Lösungsmittelbeständig. Exakt bemessen für 1200 x 800 Europalette.
- E** Contenedores apilables en PEHD (Polietileno de Alta Densidad) con paredes macizas y fondo liso. Indicados especialmente para ser utilizados en todos los sectores industriales y comerciales. Resistentes a la corrosión de ácidos, aceites y disolventes. Dimensionados para optimizar la utilización del Europallet 1200 x 800.

# CONTENITORI Sovrapponibili Serie EURO 600 X 400

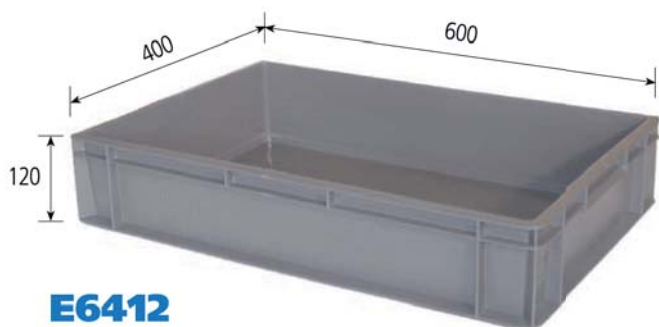

## E6412

Capacità 23 Lt.

Imballo a richiesta

Package on demand  
Emballage sur demande  
Packung auf Wunsch  
Embalaje a peticion



GRIGIO



## E6417

Capacità 33 Lt.

Imballo a richiesta

Package on demand  
Emballage sur demande  
Packung auf Wunsch  
Embalaje a peticion



GRIGIO

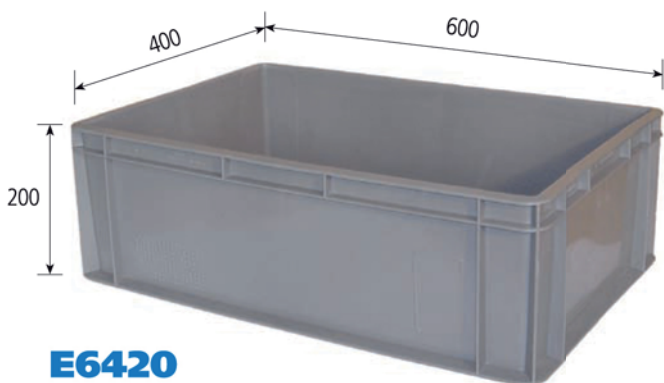

## E6420

Capacità 40 Lt.

Imballo a richiesta

Package on demand  
Emballage sur demande  
Packung auf Wunsch  
Embalaje a peticion



GRIGIO



## E6430

Capacità 60 Lt.

Imballo a richiesta

Package on demand  
Emballage sur demande  
Packung auf Wunsch  
Embalaje a peticion



GRIGIO

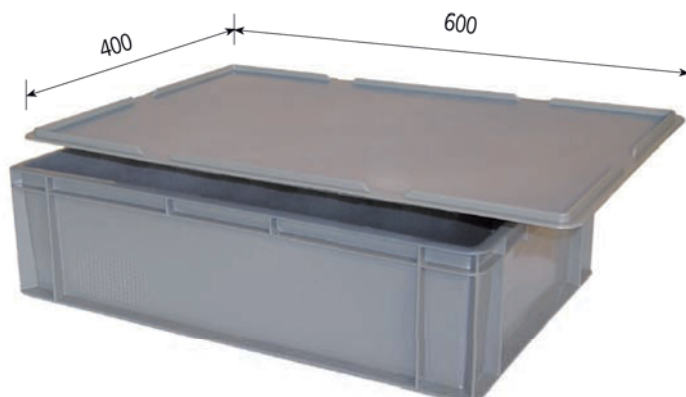

## E6400

Coperchio per contenitori

E6412 - E6417 - E6420 -

E6430

Imballo a richiesta

Package on demand  
Emballage sur demande  
Packung auf Wunsch  
Embalaje a peticion



GRIGIO

# CONTENITORI Sovrapponibili Serie MAGAZZINO



## MAG 1195

**Capacità 12 Lt.**  
**Imballo a richiesta**  
Package on demand  
Emballage sur demande  
Packung auf Wunsch  
Embalaje a peticion



GRIGIO



## MAG 1196

**Capacità 15 Lt.**  
**Imballo a richiesta**  
Package on demand  
Emballage sur demande  
Packung auf Wunsch  
Embalaje a peticion



GRIGIO

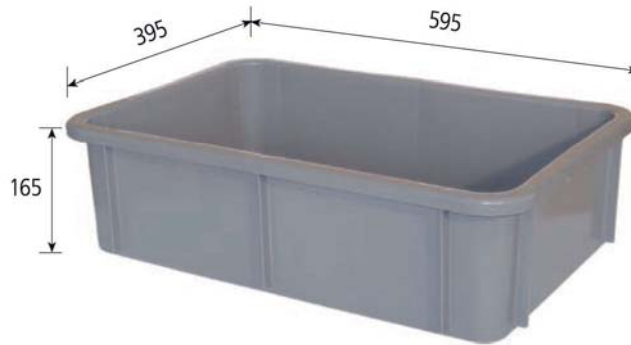

## MAG 1197

**Capacità 25 Lt.**  
**Imballo a richiesta**  
Package on demand  
Emballage sur demande  
Packung auf Wunsch  
Embalaje a peticion



GRIGIO

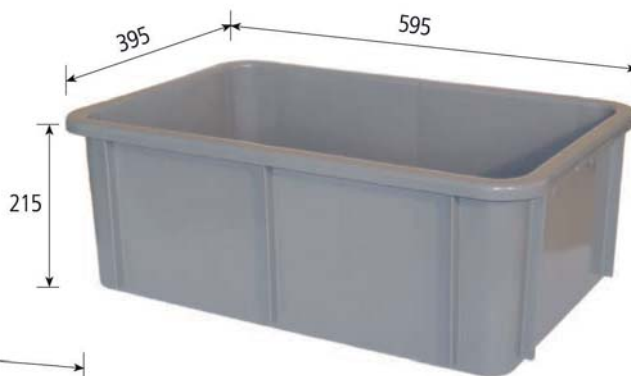

## MAG 1198

**Capacità 35 Lt.**  
**Imballo a richiesta**  
Package on demand  
Emballage sur demande  
Packung auf Wunsch  
Embalaje a peticion



GRIGIO



## MAG 1199

**Capacità 55 Lt.**  
**Imballo a richiesta**  
Package on demand  
Emballage sur demande  
Packung auf Wunsch  
Embalaje a peticion



GRIGIO



## MAG 1100

**Coperchio per  
contenitori MAG1195  
MAG1196**  
**Imballo a richiesta**

Package on demand  
Emballage sur demande  
Packung auf Wunsch  
Embalaje a peticion



GRIGIO

## MAG 1200

**Coperchio per  
contenitori MAG1197  
MAG1198 - MAG1199**  
**Imballo a richiesta**

Package on demand  
Emballage sur demande  
Packung auf Wunsch  
Embalaje a peticion



GRIGIO



ORGANIZERVALIGETTE DI  
SERVIZIO PORTAUTENSILI

## Linea "Lince"

I Cassettiere, organizer, valigette e cassette portautensili adatte ad ogni tipo di utilizzo sia professionale che hobbistico; ideali per la classificazione e l'organizzazione di minuteria, utensileria ed accessori vari.

GB Drawer units, organizers, tool cases and boxes, suitable for both professional and amateur purposes; ideal for storing and tidying small parts, tools and various accessories.

F Modules de tiroirs, classeurs, mallettes et boîtes à outils indiquées pour les besoins de tous les utilisateurs tant professionnels qu'amateurs. Instruments parfaits pour le rangement et l'organisation des petites pièces, des outils et des accessoires différents.

D Schubladenboxen, Organizer, Koffer und Werkzeugträger aller Art für professionellen Einsatz oder Hobby; ideal für die Ordnung und Organisation von Kleinteilen, Werkzeug und Zubehör.

E Cajoneras, clasificadores, maletines y cajas portaherramientas adecuadas a cualquier tipo de utilización tanto profesional como para tiempo libre: ideales para la clasificación y la organización de accesorios, útiles y accesorios diversos.

# ORGANIZER

## LINCE 301

**Imballo da 12 pz.**

Package of 12 pcs.  
Emballage de 12 pcs.  
Packung mit 12 St.  
Embalaje 12 un.



VERDE GRIGIO ROSSO BLU GIALLO

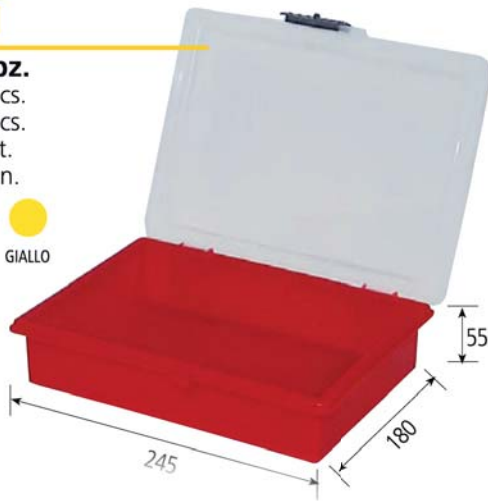

## LINCE 301/1

attrezzata con vaschette APE:  
501/3-502/1-503/1-504/1

**Imballo da 12 pz.**

Package of 12 pcs.  
Emballage de 12 pcs.  
Packung mit 12 St.  
Embalaje 12 un.



VERDE GRIGIO ROSSO BLU GIALLO



## LINCE 302/1

attrezzata con vaschette APE:  
501/6-502/2-503/2-504/2

**Imballo da 8 pz.**

Package of 8 pcs.  
Emballage de 8 pcs.  
Packung mit 8 St.  
Embalaje 8 un.



VERDE GRIGIO ROSSO BLU GIALLO



## LINCE 302

**Imballo da 8 pz.**

Package of 8 pcs.  
Emballage de 8 pcs.  
Packung mit 8 St.  
Embalaje 8 un.



VERDE GRIGIO ROSSO BLU GIALLO

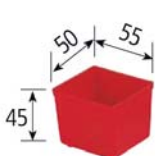

APE 501

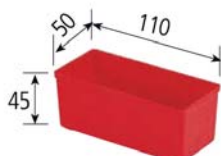

APE 502

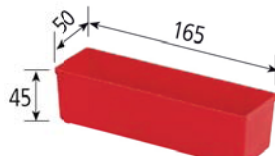

APE 503

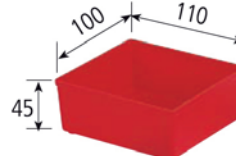

APE 504

**Imballo a richiesta**

Package on demand  
Emballage sur demande  
Packung auf Wunsch  
Embalaje a peticion

## LINCE 305

**Organizer  
a separatori estraibili**

**Imballo da 20 pz.**

Package of 20 pcs.  
Emballage de 20 pcs.  
Packung mit 20 St.  
Embalaje 20 un.



TRASPARENTE

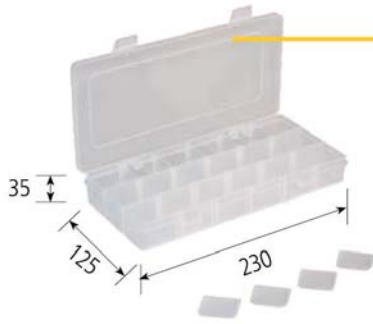

- I Organizers in PP
- GB Plastic organizer case, made of PP
- F Organizer en PP
- D Organizer aus PP
- E Organizers in PP

## LINCE 306

**Organizer  
a separatori estraibili**

**Imballo da 20 pz.**

Package of 20 pcs.  
Emballage de 20 pcs.  
Packung mit 20 St.  
Embalaje 20 un.



TRASPARENTE

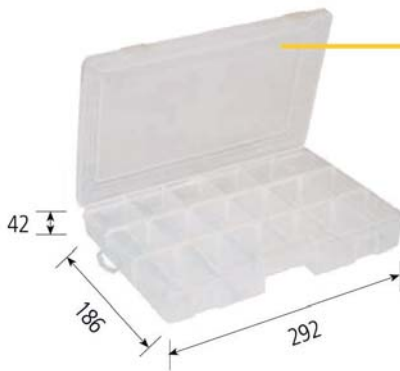

## LINCE 310

**Organizer  
a scomparti fissi**

**Imballo da 20 pz.**

Package of 20 pcs.  
Emballage de 20 pcs.  
Packung mit 20 St.  
Embalaje 20 un.



NERO

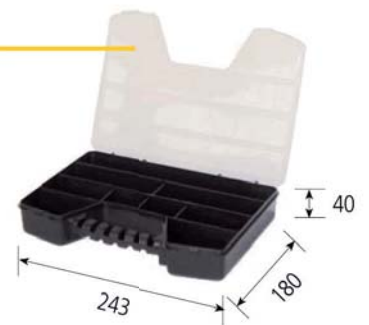

## LINCE 307

**Organizer  
a separatori estraibili**

**Imballo da 10 pz.**

Package of 10 pcs.  
Emballage de 10 pcs.  
Packung mit 10 St.  
Embalaje 10 un.



TRASPARENTE

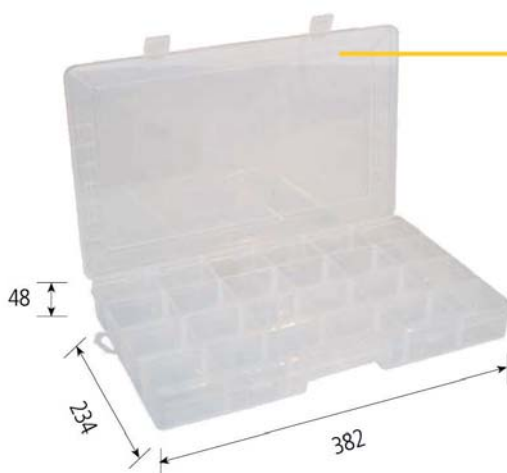

## LINCE 311

**Organizer**

**a scomparti fissi**

**Imballo da 10 pz.**

Package of 10 pcs.  
Emballage de 10 pcs.  
Packung mit 10 St.  
Embalaje 10 un.



NERO

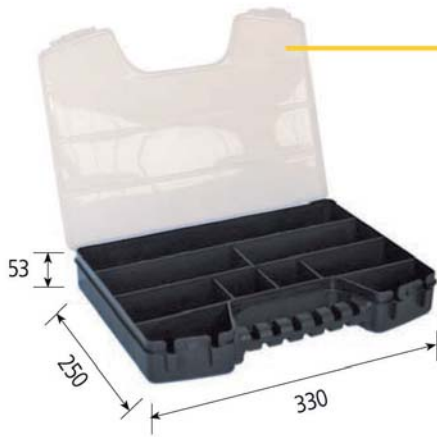

## LINCE 312

**Organizer**

**a scomparti estraibili**

**Imballo da 8 pz.**

Package of 8 pcs.  
Emballage de 8 pcs.  
Packung mit 8 St.  
Embalaje 8 un.



NERO



## LINCE 314

**Organizer**

**a vaschette estraibili**

**Imballo da 8 pz.**

Package of 8 pcs.  
Emballage de 8 pcs.  
Packung mit 8 St.  
Embalaje 8 un.



NERO

## LINCE 313

**Organizer**

**a scomparti estraibili**

**Imballo da 8 pz.**

Package of 8 pcs.  
Emballage de 8 pcs.  
Packung mit 8 St.  
Embalaje 8 un.



NERO



# VALIGETTE

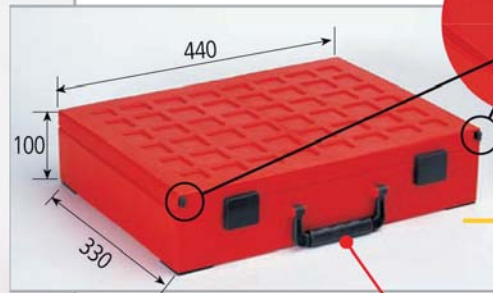

Pulsante

Fermo di sicurezza

## LINCE 330/100

Valigetta vuota

**Imballo da 4 pz.**  
 Package of 4 pcs.  
 Emballage de 4 pcs.  
 Packung mit 4 St.  
 Embalaje 8 un.

● ANTRACITE ● ROSSO ● BLU

## LINCE 331/100

attrezzata con vaschette APE  
**fondo:**  
 507/12 - 508/6 - 509/3 - 510/2  
**vassoio:**  
 505/24 - 506/12

**Imballo da 4 pz.**  
 Package of 4 pcs.  
 Emballage de 4 pcs.  
 Packung mit 4 St.  
 Embalaje 4 un.

● ANTRACITE ● ROSSO ● BLU

*Maniglia anatomica*



*Piedino antisdrucchiolo*



*Cellette per bloccaggio vaschette*

Pulsante

Fermo di sicurezza

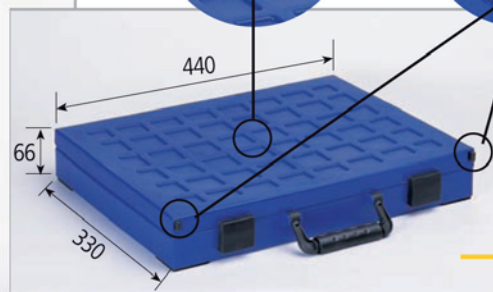
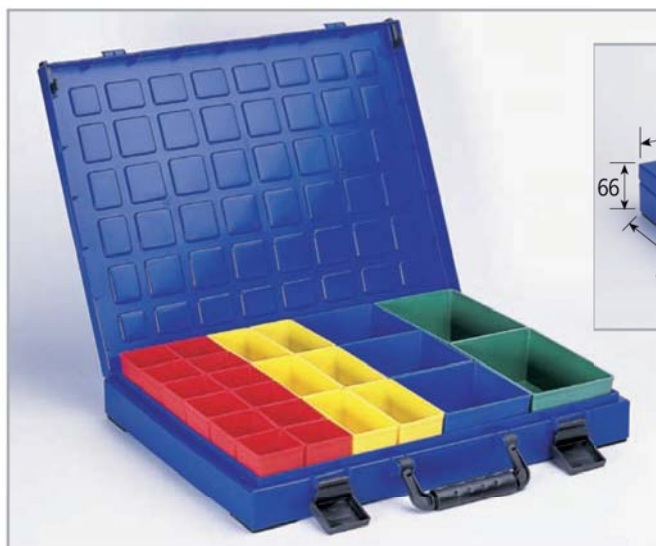

## LINCE 320/66

Valigetta vuota

**Imballo da 6 pz.**  
 Package of 6 pcs.  
 Emballage de 6 pcs.  
 Packung mit 6 St.  
 Embalaje 6 un.

● ANTRACITE ● ROSSO ● BLU

## LINCE 321/66

attrezzata con vaschette APE:  
 507/12 - 508/6 - 509/3 - 510/2

**Imballo da 6 pz.**  
 Package of 6 pcs.  
 Emballage de 6 pcs.  
 Packung mit 6 St.  
 Embalaje 6 un.

● ANTRACITE ● ROSSO ● BLU

# VALIGETTE

## Linea "Lince"

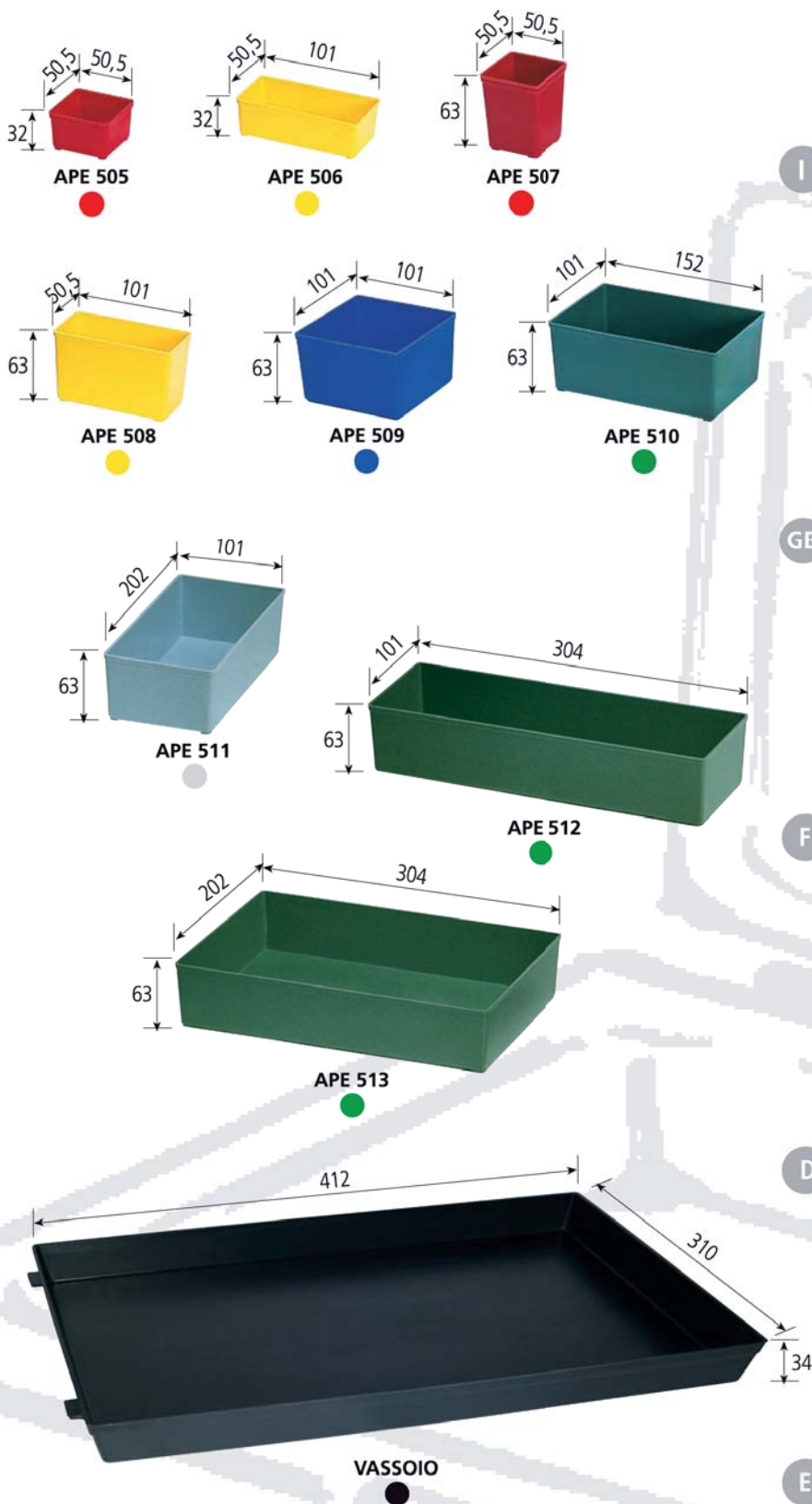

### Imballo a richiesta

Package on demand  
Emballage sur demande  
Packung auf Wunsch  
Embalaje a petición

**I** Valigette di servizio polifunzionale, solide, leggere. Dimensioni standard 440 mm x 330 mm disponibili in due altezze: 66 mm e 100 mm. Robusta struttura con due chiusure di blocco sul coperchio oltre a due fermi supplementari di sicurezza. Attrezzabili con vaschette modulari estraibili in PSAU\*\*. Possibilità di realizzare assortimenti personalizzati grazie alla modularità delle vaschette disponibili in nove differenti dimensioni. Coperchio con griglia di bloccaggio delle vaschette per la sicurezza dei contenuti. Maniglia ergonomica rivestita in gomma. Piedini di gomma antisdrucchiolo e antigraffio. Vassoio estraibile porta vaschette (per valigette h. 100) in plastica PSAU\*\*. Pratico ed efficace strumento di lavoro per montatori, riparatori, tecnici ed installatori. Idoneo per l'impiego su autoveicoli di servizio, assistenza e manutenzione.

**GB** Strong and light multipurpose service cases. Standard dimensions 440 x 330 mm, available in two standard heights – 66 and 100 mm. Solid structure with two locks and two additional security fasteners. Equipped with removable modular plastic cups, made of shockproof PS, in nine different dimensions. Ergonomic rubber lined handle, anti-slicing and anti-scratch feet. Removable plastic tray (available only for 100 mm height). These service cases are particularly suited for technicians and fitters, and for applications within maintenance and service cars.

**F** Mallettes de service polyvalentes, très solides et légères. Dimensions standard 440 mm x 330 mm, disponibles en hauteur 66 mm et 100 mm. Structure solide avec deux fermetures à blocage sur le couvercle et deux arrêts supplémentaires de sécurité. Grille d'étanchéité des godets amovibles. Neuf différentes dimensions des godets en PS ANTICHOC. Poignée ergonomique gommée et fond antiglisse avec protection contre les griffes. Plateau amovible porte godets en plastique (pour mallette hauteur 100 mm). Support très efficace pour techniciens de montage, entretien, installation. Indiqué aussi pour l'utilisation sur les véhicules de service, d'assistance, de montage, d'entretien etc.

**D** Robuster und leichter Sortimentskoffer. Standard-Abmessungen 440 mm x 330 mm, in zwei Kofferhöhen lieferbar: 66 mm und 100 mm. Solide Struktur, mit zusätzlichen Sicherheitsverriegelungen. Die herausnehmbaren Kunststoffboxen, in STOSSFESTEM PS, erlauben individuelle Ausrüstungen. Antirutschgitter im Kofferdeckel. Ergonomischer Handgriff mit Gummibeschichtung. Kratzfester Antirutschboden. Kunststoffeinsatztablett (nur für Höhe 100 mm). Ideal für Montage - Installations - und Wartungstechniker. Garantiert perfekte Logistik im Servicefahrzeug.

**E** Maletas de servicio multifuncional, solidas y ligeras, de plastico. Medidas Standard 440 mm x 330 mm, disponibles en dos alturas: 66 mm y 100 mm. Robusta estructura con doble mecanismo de cierre. Equipables con cajoncitos modulares extraibles. Posibilidad de realizar surtidos individuales aprovechando de los cajoncitos modulares en seis diferentes medidas. Tapa con reja bloque-cajoncitos, para la seguridad del contenido. Manija ergonomica engcmada. Fondo antidesliz y antiaraño. Bandeja plastica extraible porta cajoncitos (solo para maleta alta 100 mm). Ideal instrumento de trabajo para tecnicos de montaje, mantenimiento, instalacion. Aconsejado para equipar vehiculos de servicio y de asistencia tecnica.

\*\* Polistirolo antiurto

# PORTA UTENSILI

## LINCE 350

Porta utensili

Imballo da 15 pz.

Package of 15 pcs.  
Emballage de 15 pcs.  
Packung mit 15 St.  
Embalaje 15 un.



NERO



## LINCE 351

Porta utensili

Imballo da 6 pz.

Package of 6 pcs.  
Emballage de 6 pcs.  
Packung mit 6 St.  
Embalaje 6 un.



NERO



## LINCE 352

Porta utensili

Imballo da 2 pz.

Package of 2 pcs.  
Emballage de 2 pcs.  
Packung mit 2 St.  
Embalaje 2 un.



NERO



## LINCE 353

Porta utensili

Imballo da 2 pz.

Package of 2 pcs.  
Emballage de 2 pcs.  
Packung mit 2 St.  
Embalaje 2 un.



NERO



## Linea "Lince"



### LINCE 354

Porta utensili

Imballo da 10 pz.

Package of 10 pcs.

Emballage de 10 pcs.

Packung mit 10 St.

Embalaje 10 un.



NERO

- I Portautensili in PP
- GB PP Tool Holder
- F Porte-outils en PP
- D Werkzeugtasche aus PP
- E Porta-herramientas en PP



### UTILITY BOX

Porta utensili

Imballo da 4 pz.

Package of 4 pcs.

Emballage de 4 pcs.

Packung mit 4 St.

Embalaje 4 un.



ROSSO







## Linea "Service Cases"

- 1 • Service Cases è sinonimo di modularità e personalizzazione. Tutto l'interno è infatti asportabile così da poter decidere la funzione: portadocumenti, portautensili o semplice e leggera 24 H.

Caratteristiche:

- Struttura in ABS antiurto da 27/10.
- Profilo di chiusura in alluminio anticorrosione.
- Serrature incassate con chiusura a chiave
- Ulteriore serratura centrale a combinazione numerica
- Maniglia ergonomica con molla di ritorno.
- Cerniere in acciaio cromato
- Guarnizioni sul profilo in gomma nera antiurto.



# VALIGETTE



## PROFI CASES

### Service case

#### Imballo da 4 pz.

Package of 4 pcs.

Emballage de 4 pcs.

Packung mit 4 St.

Embalaje 4 un.



NERO



**GB** Service Cases guarantees modularity and customisation.

The inner part can be removed to the use: document holder or suitcase.

#### Characteristics

- Shockproof 27/10 ABS structure
- Anticorodal aluminium closing profile
- Built-in key locks
- Additional central lock with number combination
- Ergonomic handle with release spring
- Chromium-plated steel hinges
- Shockproof black rubber seals

**F** Service Cases est synonyme de modularité et de personnalisation.

On peut enlever l'intérieur et décider sa fonction: porte-documents, porte-outils ou valise 24 H.

#### Caractéristiques

- Structure en ABS anti-choc de 27/10
- Profil de fermeture en aluminium anticorodal
- Serrures encastrées avec fermeture à clé
- Ultime serrure centrale à combinaison numérique
- Poignée ergonomique avec ressort de retour
- Charnières en acier chromé
- Joints en caoutchouc noir anti-choc sur le profil

**D** Service Cases versinnbildlicht Modularität und Personalisierung.

Der gesamte Innenteil ist entfernbar, damit seine Funktion bestimmt werden kann: Konferenzmappe, Werkzeugtasche oder einfache Aktentasche.

#### Merkmale

- Struktur aus stoßfestem ABS 27/10.
- Schließprofil aus Anticorodal-Aluminium.
- Eingelassene Schlösser mit Schlüsselverschluss
- Zusätzliches zentrales Zahlenschloss
- Ergonomischer Griff mit Rückholfeder
- Verchromte Stahlscharniere
- Stoßfeste, schwarze Gummidichtung auf dem Profil.

**E** Service Cases es sinónimo de modularidad y personalización.

Su interno, en efecto, es completamente extraíble de forma que sea posible decidir específicamente su función: porta-documentos, porta-herramientas o simple 24 H.

#### Características

- Estructura en ABS anti-choque de 27/10.
- Perfil de cierre en aluminio anti-corodal.
- Cerraduras con cierre de llave
- Cerradura central adicional de clave numérica
- Manija ergonómica con muelle de retorno
- Cremalleras en acero cromado
- Guarniciones en el perfil de goma negra anti-choque.



## ROLLER CASES

### Service case

#### Imballo da 2 pz.

Package of 2 pcs.

Emballage de 2 pcs.

Packung mit 2 St.

Embalaje 2 un.



NERO



CASSETTIERE



## Linea "Fox"

- Sistema di cassetiere componibili con larghezza unica di 600 mm.
- Struttura autoportante con cassetti basculanti ed estraibili
- Involucro e cassetti in resina termoplastica ad alta resistenza
- Fissabili a parete e su supporti metallici
- Impugnatura ergonomica e porta etichette integrato nei cassetti
- Vasta gamma di supporti metallici



PLASTIC line

# CASSETTIERE

## Linea "Fox"

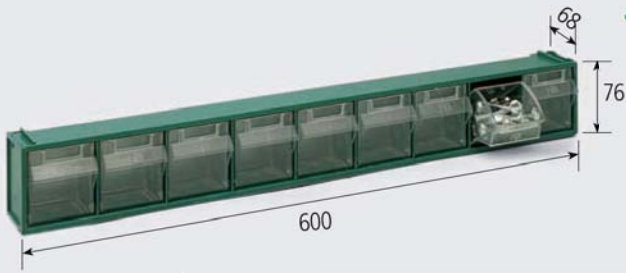

### FOX 101

#### Imballo da 1 pz.

Package of 1 pcs.  
Emballage de 1 pcs.  
Packung mit 1 St.  
Embalaje 1 un.

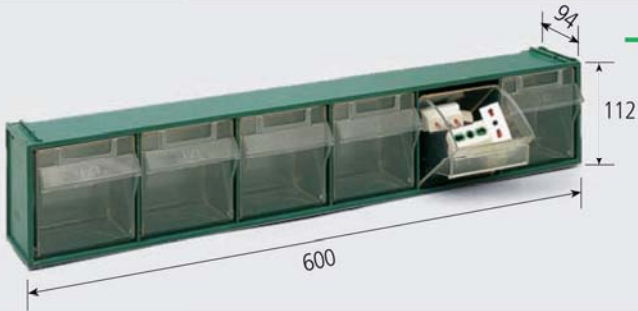

### FOX 102

#### Imballo da 1 pz.

Package of 1 pcs.  
Emballage de 1 pcs.  
Packung mit 1 St.  
Embalaje 1 un.



### FOX 103

#### Imballo da 1 pz.

Package of 1 pcs.  
Emballage de 1 pcs.  
Packung mit 1 St.  
Embalaje 1 un.

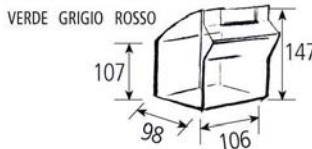

### FOX 104

#### Imballo da 1 pz.

Package of 1 pcs.  
Emballage de 1 pcs.  
Packung mit 1 St.  
Embalaje 1 un.

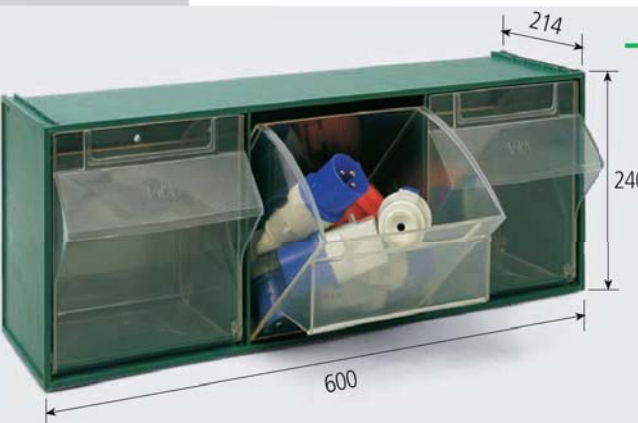
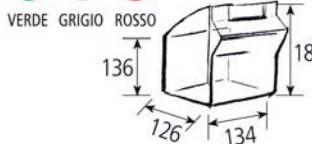

### FOX 105

#### Imballo da 1 pz.

Package of 1 pcs.  
Emballage de 1 pcs.  
Packung mit 1 St.  
Embalaje 1 un.



**GB** Modular system with self-standing structure.  
This system is composed of five unit cabinets having the same width of 600mm. The drawers are swinging and removable. The case and the drawers are made of shockproof plastic material. These units can be fixed to wall and to steel frames. Ergonomic handle and label holder integrated on the drawers.  
Numerous supports are available for the Fox units.

**F** Système modulaire de blocs tiroirs avec une largeur unique de 600 mm. Structure autoportante avec tiroirs basculants et amovibles. Caisse et tiroirs en matériel plastique très résistant. Possibilité d'utilisation murale et avec supports métalliques. Poignée ergonomique et porte étiquette intégré dans les tiroirs. De nombreux supports en acier laqué sont à disposition pour les blocs tiroirs Fox.

**D** Flexibel aufbaubares Schubladenboxensystem mit einer durchgehenden Breite von 600 mm, selbsttragende Struktur mit ausziehbaren und kippbaren Behältern. Gehäuse und Behälter aus hochwiderstandsfähigem thermoplastischem Kunststoff. Möglichkeit zur Befestigung an Wand und Metallrahmen. Ergonomisch ausgeformter Griff und in den Behälter integrierter Etikethalter. Große Auswahl an Metallrahmen.

**E** Sistema modular de cajoneras componibles con anchura única de 600 mm. Estructura autoportante con gavetas basculantes extraíbles. Cajón y gavetas fabricados en material plástico de gran resistencia. Posible utilización pensil y en soportes metálicos. Empuñadura ergonómica y porta etiqueta integrado. Amplia gama de soportes metálicos a disposición de cajoneras Fox.

# TELAI VIP

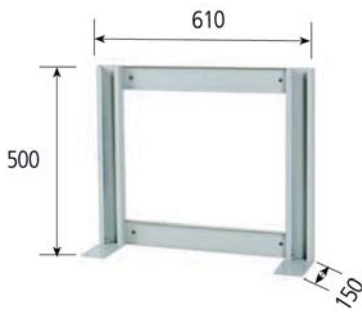

## V/401

### Telaio da banco

#### Imballo da 1 pz.

Package of	1 pcs.
Emballage de	1 pcs.
Packung mit	1 St.
Embalaje	1 un.



#### KIT STANDARD

N° 1	FOX 101
N° 1	FOX 102
N° 1	FOX 103
N° 1	FOX 104

**TOT. 24 CASSETTI**

## V/402

### Telaio da muro

#### Imballo da 1 pz.

Package of	1 pcs.
Emballage de	1 pcs.
Packung mit	1 St.
Embalaje	1 un.



#### KIT STANDARD

N° 2	FOX 101
N° 1	FOX 102
N° 2	FOX 103
N° 1	FOX 104
N° 1	FOX 105

**TOT. 41 CASSETTI**

- I** Questa serie di espositori da banco, da parete o con base di appoggio a terra, consentono un impiego molto flessibile delle cassette FOX. Infatti l'assortimento delle cassette FOX che si desidera montare sugli espositori VIP è completamente determinato dalle singole e specifiche necessità del cliente. Questi espositori sono forniti verniciati in colore GRIGIO RAL 7038.
- GB** The VIP display frame provides a flexible support format for FOX modular containers. These may either be wall or bench mounted, or, with the addition of a simple base plate may be placed on the floor. The VIP display frames are powder coated grey RAL7038 and can be tailored to suit any desired combination of FOX modular plastic containers.
- F** Les supports VIP permettent l'utilisation des blocs tiroirs FOX sur support à mur ou avec base d'appui sur plancher. Tous les supports VIP permettent le montage des éléments FOX en toutes différentes dimensions des tiroirs selon les nécessités spécifiques. Ces supports métalliques sont fournis laqués en GRIS RAL 7038.
- D** Die Tisch-, Wand- oder Standaussteller dieser Baureihe ermöglichen einen äußerst flexiblen Einsatz der FOX-Behälterboxen. Die Anordnung der FOX-Behälterboxen, die auf die VIP-Aussteller montiert werden, richtet sich vollständig nach den Wünschen und Erfordernissen des jeweiligen Kunden. Diese Aussteller sind in RAL-grau 7038 lackiert.
- E** Esta serie de expositores soportes de sobremesa, a pared o equipados de base por apoyo al suelo, permiten un uso muy flexible de las cajoneras FOX. El surtido deseado de las cajoneras FOX que se puede montar en los soportes VIP es determinado por las específicas necesidades del cliente. Los soportes VIP son barnizados en color GRIS RAL 7038.

## V/403

**Telaio con base**  
**Imballo da 1 pz.**  
 Package of 1 pcs.  
 Emballage de 1 pcs.  
 Packung mit 1 St.  
 Embalaje 1 un.

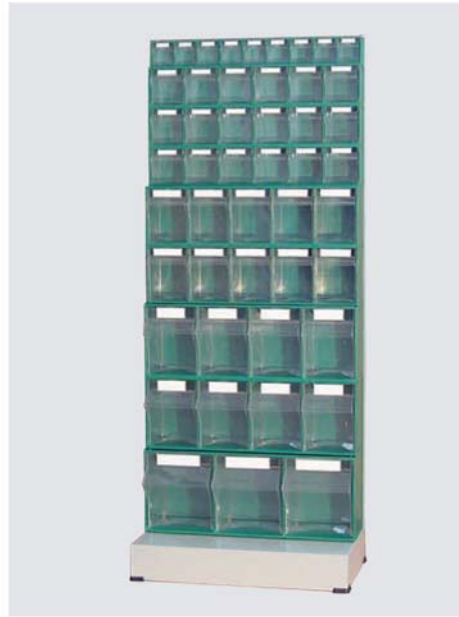

### KIT STANDARD

N° 1 FOX 101  
 N° 3 FOX 102  
 N° 2 FOX 103  
 N° 2 FOX 104  
 N° 1 FOX 105

**TOT. 48 CASSETTI**

## V/404

**Telaio con base**  
**Imballo da 1 pz.**  
 Package of 1 pcs.  
 Emballage de 1 pcs.  
 Packung mit 1 St.  
 Embalaje 1 un.

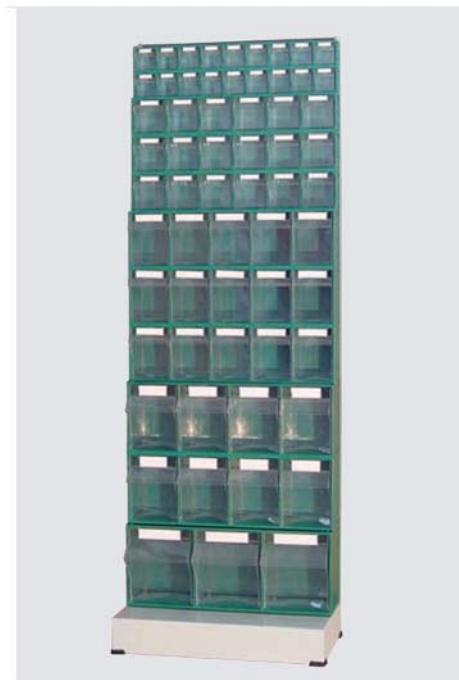

### KIT STANDARD

N° 2 FOX 101  
 N° 3 FOX 102  
 N° 3 FOX 103  
 N° 2 FOX 104  
 N° 1 FOX 105

**TOT. 59 CASSETTI**

## V/405

**Telaio con base**

**Imballo da 1 pz.**

Package of 1 pcs.

Emballage de 1 pcs.

Packung mit 1 St.

Embalaje 1 un.

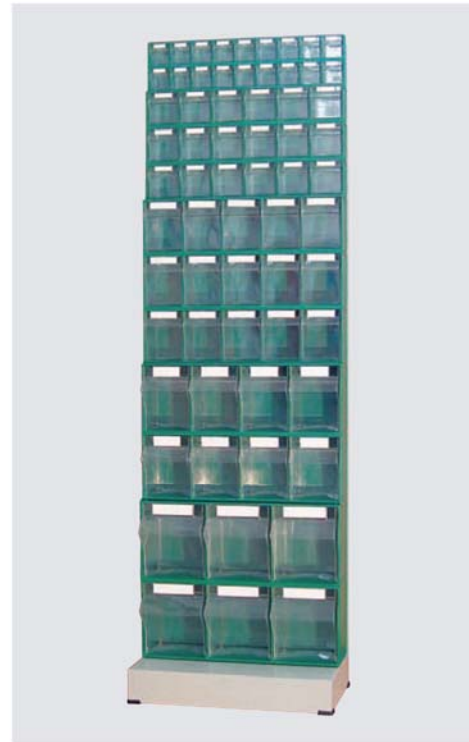

### KIT STANDARD

N° 2 FOX 101

N° 3 FOX 102

N° 3 FOX 103

N° 2 FOX 104

N° 2 FOX 105

**TOT. 65 CASSETTI**

## V/406

**Telaio bifronte c/base**

**Imballo da 1 pz.**

Package of 1 pcs.

Emballage de 1 pcs.

Packung mit 1 St.

Embalaje 1 un.



### KIT STANDARD

N° 2 FOX 101

N° 8 FOX 102

N° 6 FOX 103

N° 4 FOX 104

N° 2 FOX 105

**TOT. 118 CASSETTI**

# ESPOSITORE PROMOZIONALE

## ESPOSITORE Promozionale

**Imballo da 1 pz.**

Package of 1 pcs.  
Emballage de 1 pcs.  
Packung mit 1 St.  
Embalaje 1 un.



VERDE GRIGIO ROSSO

730



### KIT STANDARD

N° 1 FOX 101

N° 1 FOX 102

N° 1 FOX 103

N° 1 FOX 104

Con fermi per cassette

**TOT. 24 CASSETTI**

- I** Fermo per FOX
- GB** Locking bar for FOX
- F** Tringle pour FOX
- D** Haltebügel für FOX
- E** Barra de cierre para FOX

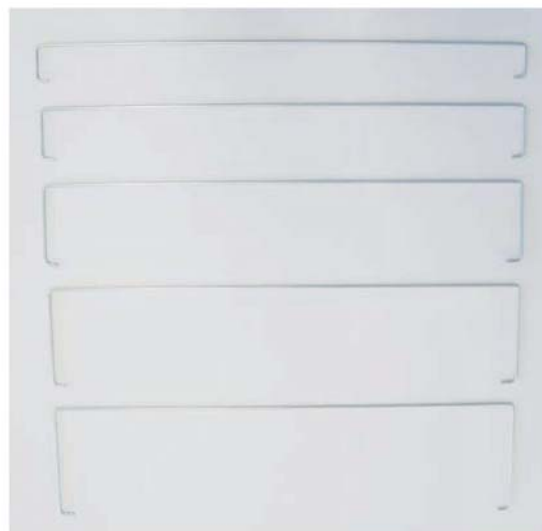

Fermo per  
**FOX 101**

Fermo per  
**FOX 102**

Fermo per  
**FOX 103**

Fermo per  
**FOX 104**

Fermo per  
**FOX 105**

Fermo rotante



Piedini in gomma





# SCAFFALE



## V/419

Scaffale

**Imballo da 1 pz.**

Package of 1 pcs.  
Emballage de 1 pcs.  
Packung mit 1 St.  
Embalaje 1 un

### KIT STANDARD

N° 2 FOX 102  
N° 2 FOX 103  
N° 2 FOX 104

**TOT. 30 CASSETTI**

- I Disponibili vuoti o con kit standard FOX. Forniti montati.
- GB This open cabinet can be supplied empty or complete with a standard kit of FOX modular containers. It comes assembled.
- F Rayonnage ; disponible vide ou équipé avec le kit FOX standard. Le set vient fourni assemblé.
- D Regal – kann leer oder ausgestattet mit einem Standard-Kit an FOX-Boxen geliefert werden. Wird montiert geliefert.
- E Huecos disponibles o con kit standard FOX. Se suministra montado.

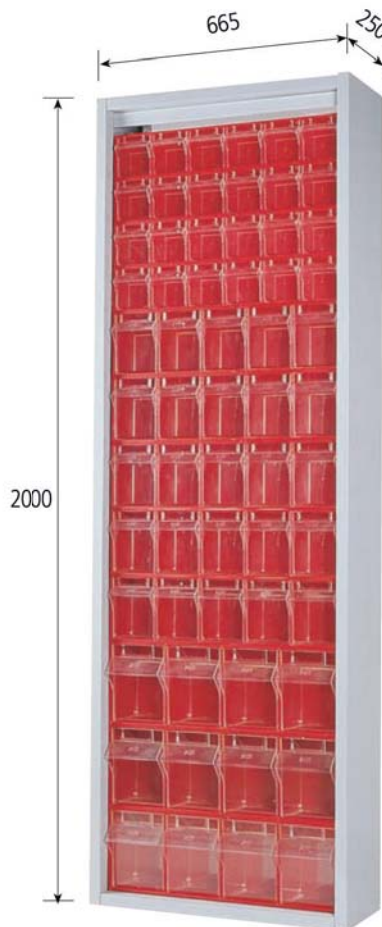

## V/420

Scaffale

**Imballo da 1 pz.**

Package of 1 pcs.  
Emballage de 1 pcs.  
Packung mit 1 St.  
Embalaje 1 un.

2000

### KIT STANDARD

N° 4 FOX 102  
N° 5 FOX 103  
N° 3 FOX 104

**TOT. 61 CASSETTI**

# ARMADI V 449

Art. **V 449** FONDO + un pannello mobile



- I Robusta struttura verniciata con polvere epossidica Grigio FAL 7038.  
L'armadio è dotato di due pannelli fissi affiancati sul fondo e di un pannello scorrevole su cuscinetti a sfera.  
Fornito smontato.
- GB Sturdy cabinets, powder coated grey RAL 7038, supplied in kit form.  
These cabinets contain two fixed rear panels sitting adjacent to each other behind one row of ball bearing mounted sliding panels.
- F Armoire solide, avec 2 panneaux fixes placés l'un à côté de l'autre sur le dos et 1 panneau coulissant sur roulement à billes.  
Structure robuste, peinte avec poudre époxyde gris RAL 7038.  
L'armoire est fournie démontée.
- D Robuster Schrank aus Stahlblech, pulverbeschichtet, grau RAL 7038.  
Besteht aus zwei feststehenden Rückwänden, sowie aus ein feststehenden auf Kugellager laufenden, verschiebbaren Einsatzpaneel. Wird zerlegt geliefert.
- E Solido armario dotato de 2 paneles firmes aproximados en el dorso y equipados de 1 panel corredizo sobre cojinetes.  
El armario es barnizado con polvos epoxidicos Gris RAL 7038.  
El armario se entrega desmontado.

- I PORTATA SINGOLO PANNELLO : KG 150
- GB CAPACITY OF EACH PANEL : KG 150
- F CHARGE DE CHAQUE PANNEAU : KG 150
- D TRAGFÄHIGKEIT JE SCHIEBEWAND : KG 150
- E CAPACIDAD POR CADA PANEL : KG 150

# ALLESTIMENTO ARMADI

Art. **V 449** FONDO + un pannello mobile

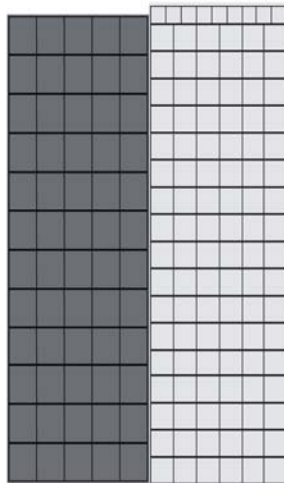

## **V 449 Standard** Totale 231 cassetti

- **FONDO:**  
24 FOX 103 = 120 Cassetti
- **PANNELLO:**  
1 FOX 101 = 9 Cassetti  
17 FOX 102 = 102 Cassetti

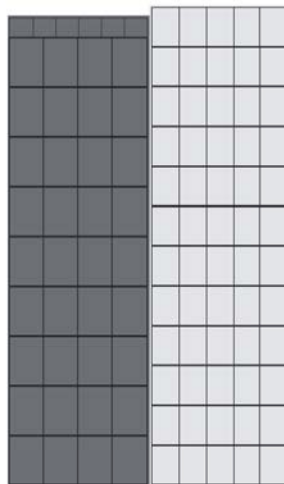

## **V 449 -1V** Totale 144 cassetti

- **FONDO:**  
2 FOX 102 = 12 Cassetti  
18 FOX 104 = 72 Cassetti
- **PANNELLO:**  
12 FOX 103 = 60 Cassetti

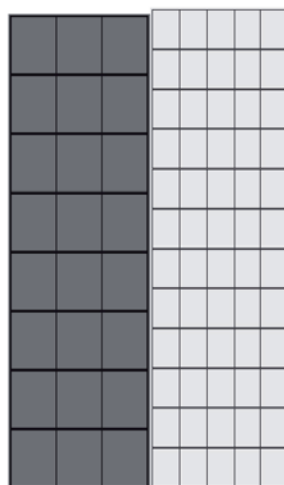

## **V 449 -2V** Totale 108 cassetti

- **FONDO:**  
16 FOX 105 = 48 Cassetti
- **PANNELLO:**  
12 FOX 103 = 60 Cassetti

# ARMADI ATTREZZATI V 450

## Art. V 450 FONDO + 2 pannelli mobili



- I Robusta struttura verniciata con polvere epossidica Grigio RAL 7038. L'armadio è dotato di due pannelli fissi affiancati sul fondo e di due pannelli scorrevoli su cuscinetti a sfera. Fornito smontato.
- GB Sturdy cabinets, powder coated grey RAL 7038, supplied in kit form. These cabinets contain two fixed rear panels sitting adjacent to each other behind two rows of ball bearing mounted sliding panels.
- F Armoire solide, avec 2 panneaux fixes placés l'un à côté de l'autre sur le dos et 2 panneaux coulissants sur roulement à billes. Structure robuste, peinte avec poudre époxyde gris RAL 7038. L'armoire est fournie démontée.
- D Robuster Schrank aus Stahlblech, pulverbeschichtet, grau RAL 7038. Besteht aus zwei feststehenden Rückwänden, sowie aus zwei auf Kugellager laufenden, verschiebbaren Einsatzpaneelen. Wird zerlegt geliefert.
- E Solido armario dotato de 2 paneles firmes aproximados en el dorso y equipados de 2 paneles corredizos sobre cojinetes. El armario es barnizado con polvos epoxidicos Gris RAL 7038. El armario se entrega desmontado.

- I PORTATA SINGOLO PANNELLO : KG 150
- GB CAPACITY OF EACH PANEL : KG 150
- F CHARGE DE CHAQUE PANNEAU : KG 150
- D TRAGFÄHIGKEIT JE SCHIEBEWAND : KG 150
- E CAPACIDAD POR CADA PANEL : KG 150

## Art. **V 450** FONDO + 2 pannelli mobili

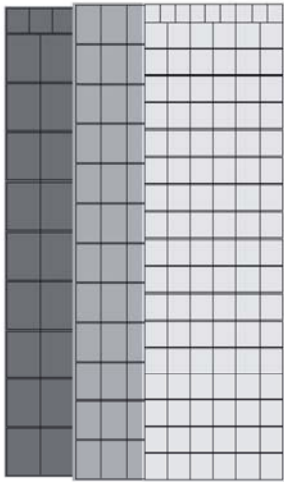

### **V 450 Standard** Totale 255 cassette

- FONDO:
  - 2 FOX 102 = 12 cassette
  - 18 FOX 104 = 72 cassette
- 1° PANNELLO:
  - 12 FOX 103 = 60 cassette
- 2° PANNELLO:
  - 1 FOX 101 = 9 cassette
  - 17 FOX 102 = 102 cassette

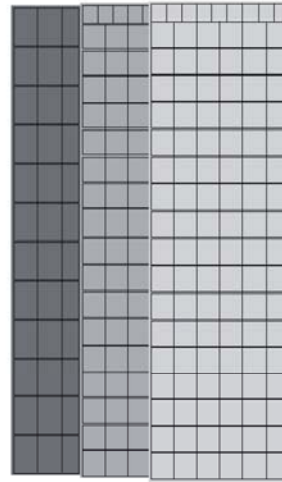

### **V 450 /1V** Totale 342 cassette

- FONDO:
  - 24 FOX 103 = 120 cassette
- 1° PANNELLO:
  - 1 FOX 101 = 9 cassette
  - 17 FOX 102 = 102 cassette
- 2° PANNELLO:
  - 1 FOX 101 = 9 cassette
  - 17 FOX 102 = 102 cassette

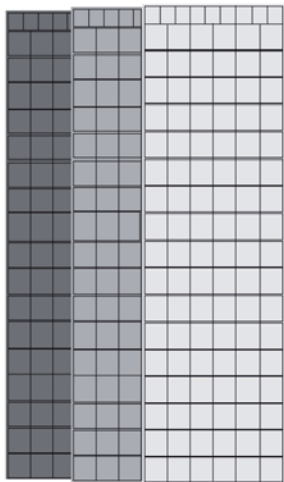

### **V 450 /2V** Totale 444 cassette

- FONDO:
  - 2 FOX 101 = 18 cassette
  - 34 FOX 102 = 204 cassette
- 1° PANNELLO:
  - 1 FOX 101 = 9 cassette
  - 17 FOX 102 = 102 cassette
- 2° PANNELLO:
  - 1 FOX 101 = 9 cassette
  - 17 FOX 102 = 102 cassette

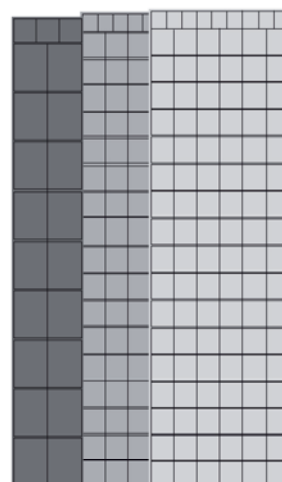

### **V 450 /3V** Totale 306 cassette

- FONDO:
  - 2 FOX 102 = 12 cassette
  - 18 FOX 104 = 72 cassette
- 1° PANNELLO:
  - 1 FOX 101 = 9 cassette
  - 17 FOX 102 = 102 cassette
- 2° PANNELLO:
  - 1 FOX 101 = 9 cassette
  - 17 FOX 102 = 102 cassette

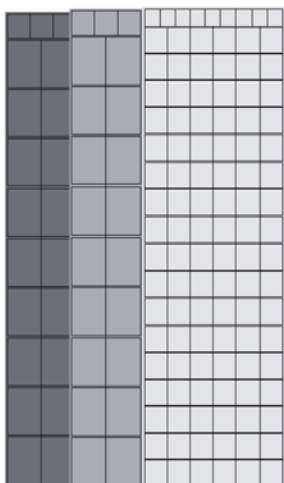

### **V 450 /4V** Totale 237 Cassetti

- FONDO:
  - 2 FOX 102 = 12 cassette
  - 18 FOX 104 = 72 cassette
- 1° PANNELLO:
  - 1 FOX 102 = 6 cassette
  - 9 FOX 104 = 36 cassette
- 2° PANNELLO:
  - 1 FOX 101 = 9 cassette
  - 17 FOX 102 = 102 cassette

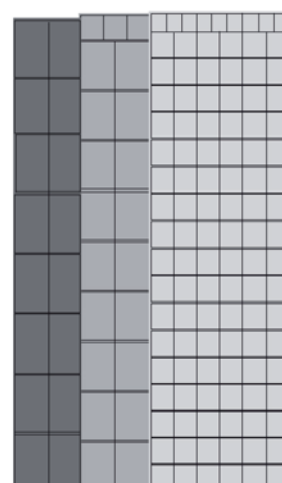

### **V 450 /5V** Totale 201 Cassetti

- FONDO:
  - 16 FOX 105 = 48 cassette
- 1° PANNELLO:
  - 1 FOX 102 = 6 cassette
  - 9 FOX 104 = 36 cassette
- 2° PANNELLO:
  - 1 FOX 101 = 9 cassette
  - 17 FOX 102 = 102 cassette

# ARMADI ATTREZZATI V 451

## Art. V 451 FONDO + 3 pannelli mobili

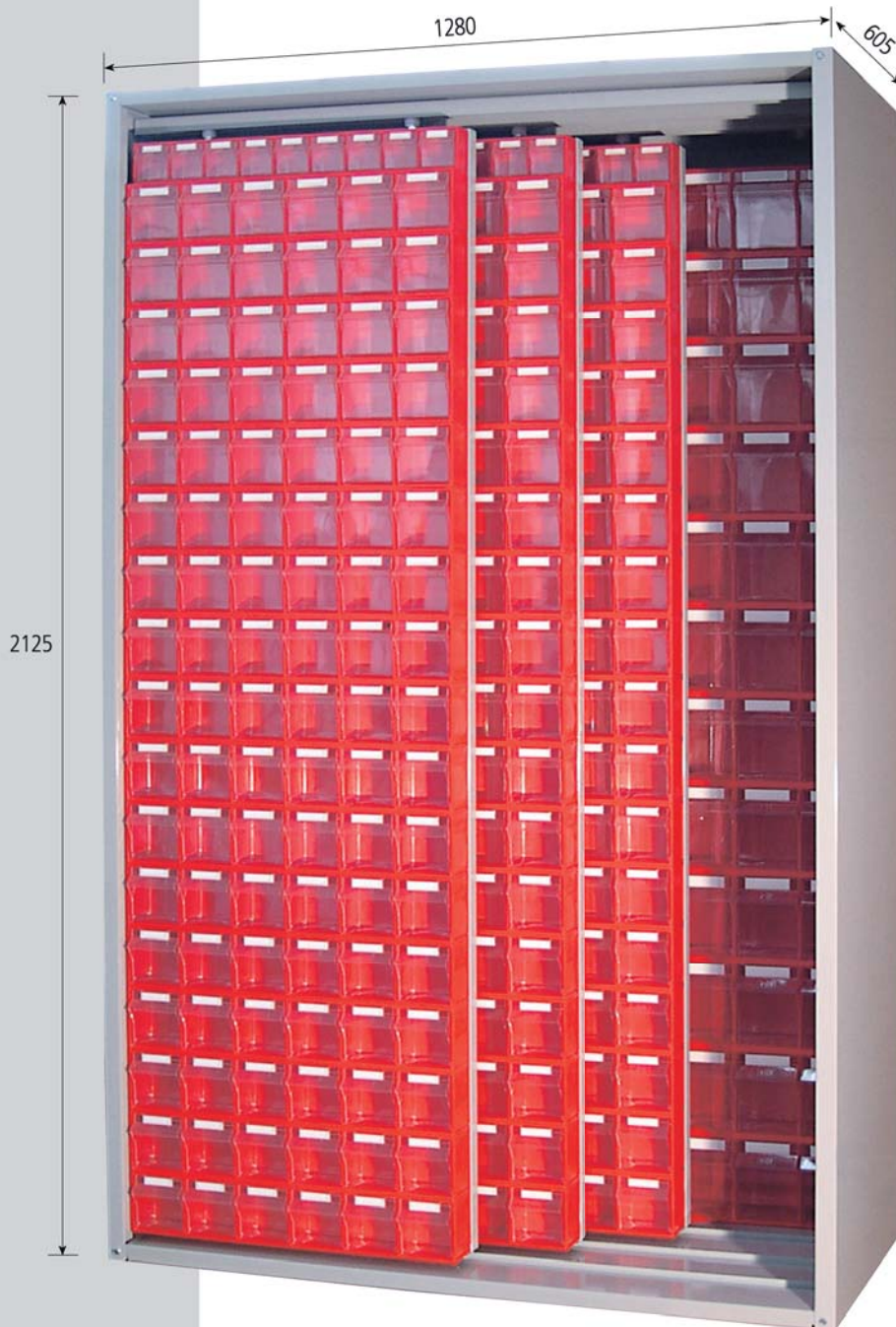

- I Robusta struttura verniciata con polvere epossidica Grigio RAL 7038.  
L'armadio è dotato di due pannelli fissi affiancati sul fondo e di tre pannelli scorrevoli su cuscinetti a sfera.  
Fornito smontato.
- GB Sturdy cabinets, powder coated grey RAL 7038, supplied in kit form.  
These cabinets contain two fixed rear panels sitting adjacent to each other behind three ball bearing mounted sliding panels.
- F Armoire solide, avec 2 panneaux fixes placés l'un à côté de l'autre sur le dos et 3 panneaux coulissants sur roulement à billes.  
Structure robuste, peinte avec poudre époxyde gris RAL 7038.  
L'armoire est fournie démontée.
- D Robuster Schrank aus Stahlblech, pulverbeschichtet, grau RAL 7038.  
Besteht aus zwei feststehenden Rückwänden, sowie aus drei auf Kugellager laufenden verschiebbaren Einsatzpaneelen.  
Wird zerlegt geliefert.
- E Solido armario dotado de 2 paneles fijos aproximados en el dorso y equipados de 3 paneles correderos sobre cojinetes.  
El armario es barnizado con polvos epoxidicos Gris RAL 7038.  
El armario se entrega desmontado.

- I PORTATA SINGOLO PANNELLO : KG 150
- GB CAPACITY OF EACH PANEL : KG 150
- F CHARGE DE CHAQUE PANNEAU : KG 150
- D TRAGFÄHIGKEIT JESCHIEBEWAND : KG 150
- E CAPACIDAD POR CADA PANEL : KG 150

# ALLESTIMENTO ARMADI

## Art. **V 451** FONDO + 3 pannelli mobili

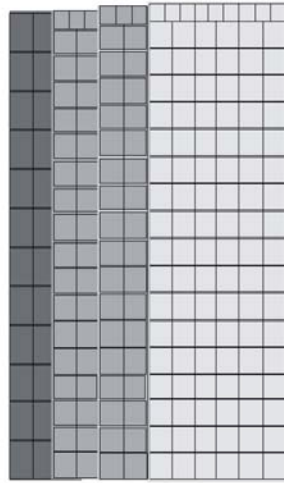

### **V 451/Standard** Totale 453 cassetti

- FONDO:  
24 FOX 103 = 120 cassetti
- 1° PANNELLO:  
1 FOX 101 = 9 cassetti  
17 FOX 102 = 102 cassetti
- 2° PANNELLO:  
1 FOX 101 = 9 cassetti  
17 FOX 102 = 102 cassetti
- 3° PANNELLO:  
1 FOX 101 = 9 cassetti  
17 FOX 102 = 102 cassetti

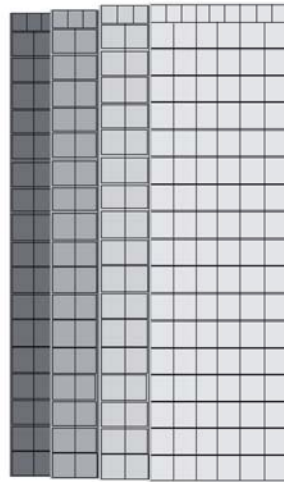

### **V 451/1V** Totale 555 cassetti

- FONDO:  
2 FOX 101 = 18 cassetti  
34 FOX 102 = 204 cassetti
- 1° PANNELLO:  
1 FOX 101 = 9 cassetti  
17 FOX 102 = 102 cassetti
- 2° PANNELLO:  
1 FOX 101 = 9 cassetti  
17 FOX 102 = 102 cassetti
- 3° PANNELLO:  
1 FOX 101 = 9 cassetti  
17 FOX 102 = 102 cassetti

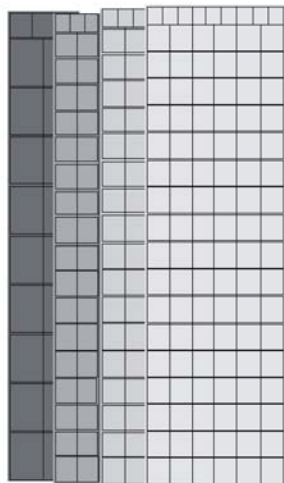

### **V 451 /2V** Totale 417 Cassetti

- FONDO:  
2 FOX 102 = 12 cassetti  
18 FOX 104 = 72 cassetti
- 1° PANNELLO:  
1 FOX 101 = 9 cassetti  
17 FOX 102 = 102 cassetti
- 2° PANNELLO:  
1 FOX 101 = 9 cassetti  
17 FOX 102 = 102 cassetti
- 3° PANNELLO:  
1 FOX 101 = 9 cassetti  
17 FOX 102 = 102 cassetti

# ARMADI ATTREZZATI V 452

Art. **V 452** FONDO + 3 pannelli mobili



- I Robusta struttura verniciata con polvere epossidica Grigio RAL 7038. L'armadio è dotato di due pannelli fissi affiancati sul fondo e di tre pannelli scorrevoli su cuscinetti a sfera. Fornito smontato.
- GB Sturdy cabinets, powder coated grey RAL 7038, supplied in kit form. These cabinets contain two fixed rear panels sitting adjacent to each other behind three ball bearing mounted sliding panels.
- F Armoire solide, avec 2 panneaux fixes placés l'un à côté de l'autre sur le dos et 3 panneaux coulissants sur roulement à billes. Structure robuste, peinte avec poudre époxyde gris RAL 7038. L'armoire est fournie démontée.
- D Robuster Schrank aus Stahlblech, pulverbeschichtet, grau RAL 7038. Besteht aus zwei feststehenden Rückwänden, sowie aus drei auf Kugellager laufenden verschiebbaren Einsatzpaneelen. Wird zerlegt geliefert.
- E Solido armario dotato de 2 paneles fijas aproximados en el dorso y equipados de 3 paneles corredizos sobre cojinetes. El armario es barnizado con polvos epoxidicos Gris RAL 7038. El armario se entrega desmontado.

- I PORTATA SINGOLO PANNELLO : KG 150
- GB CAPACITY OF EACH PANEL : KG 150
- F CHARGE DE CHAQUE PANNEAU : KG 150
- D TRAGFÄHIGKEIT JESCHIEBEWAND : KG 150
- E CAPACIDAD POR CADA PANEL : KG 150



# ALLESTIMENTO ARMADI

## Art. **V 452** FONDO + 3 pannelli mobili

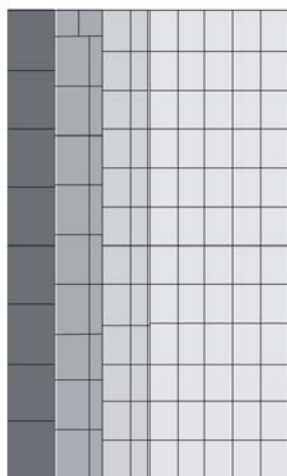

### **V 452/Standard** Totale 210 cassette

- FONDO:  
16 FOX 105 = 48 cassette
- 1° PANNELLO:  
1 FOX 102 = 6 cassette  
9 FOX 104 = 36 cassette
- 2° PANNELLO:  
12 FOX 103 = 60 cassette
- 3° PANNELLO:  
12 FOX 103 = 60 cassette

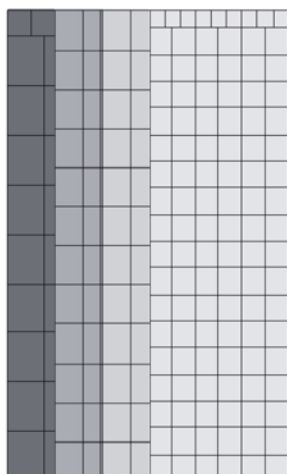

### **V 452/1V** Totale 315 cassette

- FONDO:  
2 FOX 102 = 12 cassette  
18 FOX 104 = 72 cassette
- 1° PANNELLO:  
12 FOX 103 = 60 cassette
- 2° PANNELLO:  
12 FOX 103 = 60 cassette
- 3° PANNELLO:  
1 FOX 101 = 9 cassette  
17 FOX 102 = 102 cassette

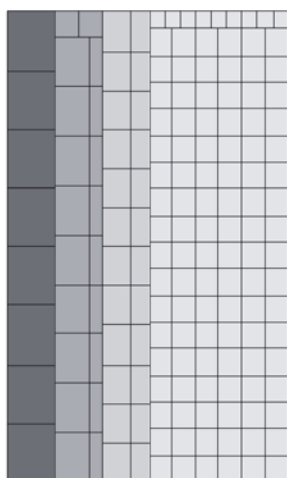

### **V 452/2V** Totale 261 cassette

- FONDO:  
16 FOX 105 = 48 cassette
- 1° PANNELLO:  
1 FOX 102 = 6 cassette  
9 FOX 104 = 36 cassette
- 2° PANNELLO:  
12 FOX 103 = 60 cassette
- 3° PANNELLO:  
1 FOX 101 = 9 cassette  
17 FOX 102 = 102 cassette

# ARMADI ATTREZZATI V 455

Art. **V 455** FONDO + 6 pannelli mobili



**I** Robusta struttura verniciata con polvere epossidica Grigio RAL 7038. L'armadio è dotato di quattro pannelli fissi affiancati sul fondo e di sei pannelli scorrevoli su cuscinetti a sfera. Fornito smontato.

**GB** Sturdy cabinets, powder coated grey RAL 7038, supplied in kit form. These cabinets contain four fixed rear panels sitting adjacent to each other behind six ball bearing mounted sliding panels.

**F** Armoire solide, avec 4 panneaux fixes placés les uns à côté des autres sur le dos et 6 panneaux coulissants sur roulement à billes. Structure robuste, peinte avec poudre époxyde gris RAL 7038. L'armoire est fournie démontée.

**D** Robuster Schrank aus Stahlblech, pulverbeschichtet, grau RAL 7038. Besteht aus vier feststehenden Rückwänden, sowie aus sechs auf Kugellager laufenden verschiebbaren Einsatzpaneelen. Wird zerlegt geliefert.

**E** Solido armario dotato de 4 paneles fijas aproximados en el dorso y equipados de 6 paneles corredizos sobre cojinetes. El armario es barnizado con polvos epoxídicos Gris RAL 7038. El armario se entrega desmontado.

**I** PORTATA SINGOLO PANNELLO : KG 150

**GB** CAPACITY OF EACH PANEL : KG 150

**F** CHARGE DE CHAQUE PANNEAU : KG 150

**D** TRAGFÄHIGKEIT JE SCHIEBEWAND : KG 150

**E** CAPACIDAD POR CADA PANEL : KG 150

# ALLESTIMENTO ARMADI

## Art. **V 455** FONDO + 6 pannelli mobili

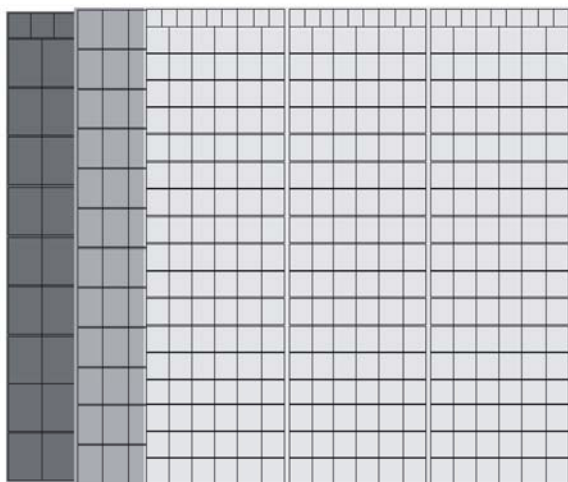

### **V 455/Standard** Totale 681 cassetti

- FONDO:  
4 FOX 102 = 24 cassetti  
36 FOX 104 = 144 cassetti
- 1ª FILA DI PANNELLI:  
36 FOX 103 = 180 cassetti
- 2ª FILA DI PANNELLI:  
3 FOX 101 = 27 cassetti  
51 FOX 102 = 306 cassetti

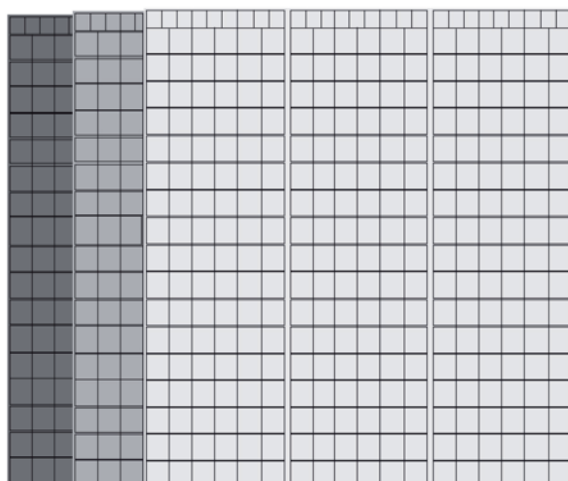

### **V 455/1V** Totale 906 cassetti

- FONDO:  
48 FOX 103 = 240 cassetti
- 1ª FILA DI PANNELLI:  
3 FOX 101 = 27 cassetti  
51 FOX 102 = 306 cassetti
- 2ª FILA DI PANNELLI:  
3 FOX 101 = 27 cassetti  
51 FOX 102 = 306 cassetti

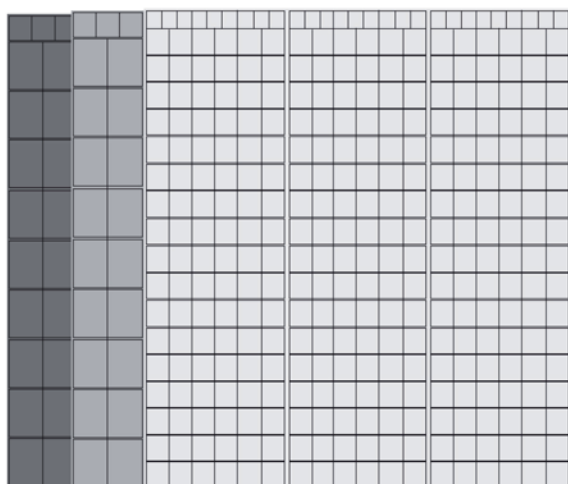

### **V 455/2V** Totale 555 cassetti

- FONDO:  
32 FOX 105 = 96 cassetti
- 1ª FILA DI PANNELLI:  
3 FOX 102 = 18 cassetti  
27 FOX 104 = 108 cassetti
- 2ª FILA DI PANNELLI:  
3 FOX 101 = 27 cassetti  
51 FOX 102 = 306 cassetti

# ARMADI ATTREZZATI V 460

## Art. V 460 + 3 pannelli bifronte estraibili



- I PORTATA SINGOLO PANNELLO : KG 200
- GB CAPACITY OF EACH PANEL : KG 200
- F CHARGE DE CHAQUE PANNEAU : KG 200
- D TRAGFÄHIGKEIT JE SCHIEBEWAND : KG 200
- E CAPACIDAD POR CADA PANEL : KG 200

**I** Robusta struttura verniciata con polvere epossidica Grigio RAL 7038. L'armadio e' dotato di 3 pannelli bifronte ad estrazione frontale. I pannelli sono sostenuti e guidati da robuste guide telescopiche montate su cuscinetti a sfera che garantiscono scorrevolezza e una silenziosa apertura anche a pieno carico. **IMPORTANTE PER LA SICUREZZA!** Questo armadio e' fornito di dispositivo di apertura singola dei pannelli. Con l'armadio vengono fornite due staffe per il fissaggio a parete e/o a pavimento. Fornito smontato.

**GB** Solid cupboard with three front extractable double-sided sliding panels. These panels run on silent yet sturdy ball bearing telescopic guide rails. Each panel comes complete with a lock. A safety device assembled to each panel prevents two panels to be opened simultaneously. The cupboard is supplied with two brackets to fasten either to wall or to floor slab. Powder coating in grey, RAL 7038. Supplied to be assembled.

**F** Armoire très robuste équipée de 3 panneaux double face coulissants transversalement. Les panneaux se manoeuvrent facilement car ils sont montés sur des rails télescopiques équipés de roulements à billes. Chaque panneau est doté d'une serrure. **SECURITE A L'OUVERTURE.** Pour éviter tout risque de basculement, les armoires sont fourries avec un mécanisme qui ne permet l'ouverture que d'un seul panneau à la fois. De plus, chaque armoire est fournie avec des pattes pour la fixation au mur ou au plancher. Finition peinture poudre époxy coloris gris RAL 7038. Armoire livrée démontée.

**D** Robuster Schrank mit 3 senkrechten und vollausziehbaren Schüben. Jeder Schub ist doppelseitig bestückbar und auf kugelgelagerten Teleskopschienen montiert. Für die Sicherheit ist jeder Schub mit einem Schloss bestückt. De Schränke sind mit einem Öffnungssicherheitssystem gebaut. Es kann immer nur ein Schub geöffnet werden. Zur Boden und Wandbefestigung sind zusätzliche 2 Befestigungsteile mitgeliefert. Epoxy Farbe Grau RAL 7038. Die Schränke werden zerlegt geliefert.

**E** Solido armario equipado con 3 paneles bifrontales. Estos paneles se extraen sobre el frente de l'armario y escurren sobre robustos y silenciosos rails telescopicos. Cada panel tiene la cerradura. Todo es barnizado con polvos epoxidicos gris RAL 7038. **!!MUY IMPORTANTE PARA LA SEGURIDAD!!** El armario esta dotado de mecanismo el cual consente la extracior de un unico panel por vez. Con el armario se entregan 2 estribos para fijar el armario a pared o al suelo. El armario es entregado desmontado.

# ALLESTIMENTO ARMADI

Art. **V 460** + 3 pannelli bifronte estraibili

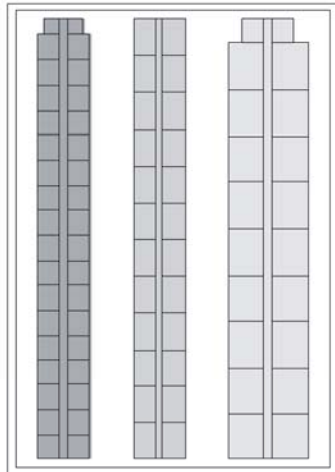

## **V 460/Standard** Totale 426 cassette

- 1° PANNELLO:  
2 FOX 101 = 18 cassette  
34 FOX 102 = 204 cassette
- 2° PANNELLO:  
24 FOX 103 = 120 cassette
- 3° PANNELLO:  
2 FOX 102 = 12 cassette  
18 FOX 104 = 72 cassette

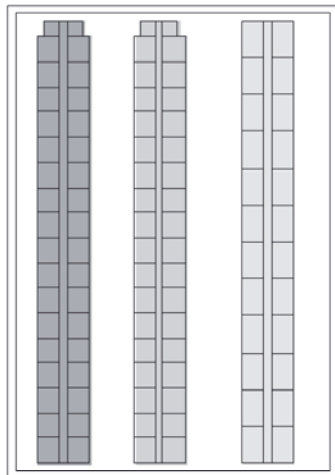

## **V 460/1V** Totale 564 cassette

- 1° PANNELLO:  
2 FOX 101 = 18 cassette  
34 FOX 102 = 204 cassette
- 2° PANNELLO:  
2 FOX 101 = 18 cassette  
34 FOX 102 = 204 cassette
- 3° PANNELLO:  
24 FOX 103 = 120 cassette

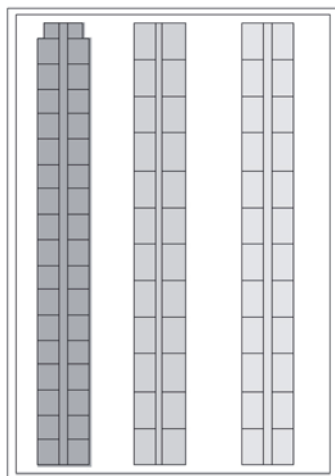

## **V 460/2V** Totale 462 cassette

- 1° PANNELLO:  
2 FOX 101 = 18 cassette  
34 FOX 102 = 204 cassette
- 2° PANNELLO:  
24 FOX 103 = 120 cassette
- 3° PANNELLO:  
24 FOX 103 = 120 cassette

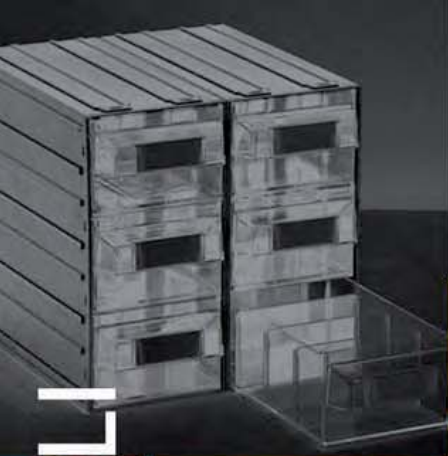

CASSETTIERE COMPONIBILI

## Linea "Puma"

- Cassettera modulare componibile ad incastro che permette di realizzare strutture autoportanti. Linea ergonomica. Spigoli arrotondati per garantire la sicurezza nella manipolazione. Impugnatura dotata di portaetichetta. Funzionalità super collaudata.

# CASSETTIERE

## Linea "Puma"

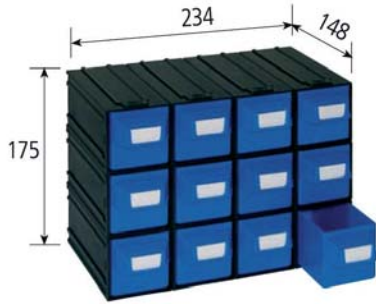

### PUMA 202 PUMA 202/T\*

composizione da 12 cassetti

**Imballo da 12 pz.**

**COLORE:**

corpo ● NERO

cassetti

● VERDE ● GRIGIO ● ROSSO ● BLU ● GIALLO ● TRASPARENTE

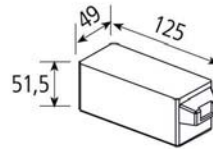

**GB** Modular storage box for loose items. Possibility to erect free standing wall units. Made of shockproof polystyrene.

**F** Blocs à tiroirs entièrement emboîtables par des coulisses à queue d'aronde. Caisnes et tiroirs sont réalisés en polystyrène antichoc.

**D** Modulare Schubladenbox. Gehäuse und Schubladen aus bruchfestem Kunststoff.

**E** Cajonera modular de plastica con funda ensamblable y autoportante. Fundas y cajones en polistireno antichoc.



### PUMA 203 PUMA 203/T\*

composizione da 6 cassetti

**Imballo da 12 pz.**

**COLORE:**

corpo ● NERO

cassetti

● VERDE ● GRIGIO ● ROSSO ● BLU ● GIALLO ● TRASPARENTE

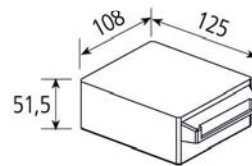

### PUMA 204 PUMA 204/T\*

composizione da 3 cassetti

**Imballo da 12 pz.**

**COLORE:**

corpo ● NERO

cassetti

● VERDE ● GRIGIO ● ROSSO ● BLU ● GIALLO ● TRASPARENTE

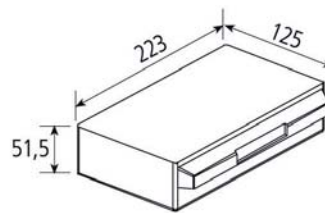

### PUMA 205 PUMA 205/T\* MISTA

composizione da 7 cassetti

**Imballo da 12 pz.**

**COLORE:**

corpo ● NERO

cassetti

● VERDE ● GRIGIO ● ROSSO ● BLU ● GIALLO ● TRASPARENTE

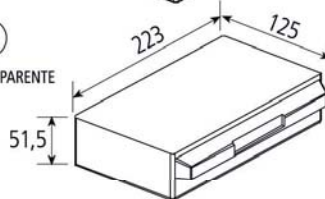
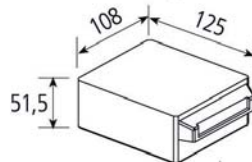
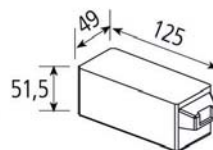

\*cassetti trasparenti



## PUMA 206 PUMA 206/T\*

composizione da 6 cassetti  
dotata di 12 separatori estraibili

**Imballo da 1 pz.**

**COLORE:**

**corpo** ● NERO

**cassetti**



VERDE GRIGIO TRASPARENTE

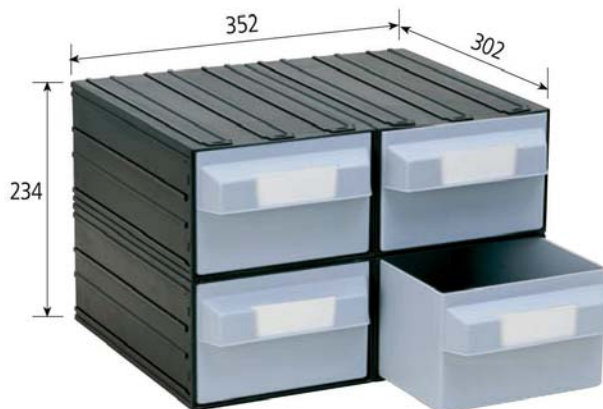
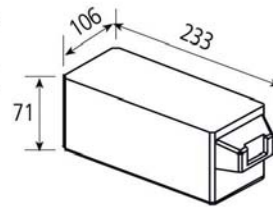

## PUMA 207 PUMA 207/T\*

composizione da 4 cassetti  
attrezzabili con vaschette  
APE 531

**Imballo da 1 pz.**

**COLORE:**

**corpo** ● NERO

**cassetti**



VERDE GRIGIO TRASPARENTE

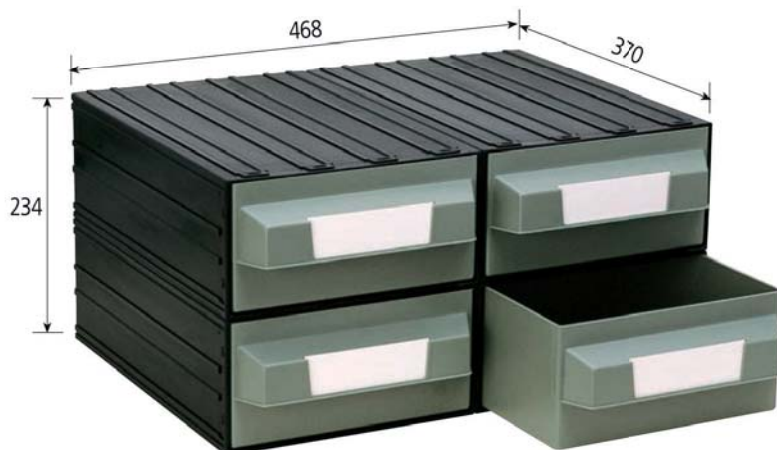

## PUMA 208 PUMA 208/T\*

composizione da 4 cassetti  
attrezzabili con vaschette  
APE 532 e APE 533

**Imballo da 1 pz.**

**COLORE:**

**corpo** ● NERO

**cassetti**



VERDE GRIGIO TRASPARENTE

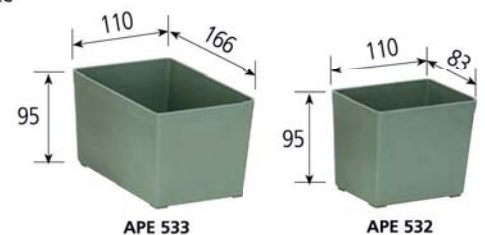

\*cassetti trasparenti

vaschette APE 531 - 532 - 533  
disponibili solo in colore verde





# CONTENITORI

*Boxes · Bacs · Contenedores · Behälter*





## Contenitori KEY BOX

Contenitori sovrapponibili prodotti in materiale termoplastico resistente ad acidi, olii e solventi e a temperature da -40° a +80°C, con fermi anteriori e fondo piatto per l'utilizzo su piani inclinati, pareti interne lisce per una facile pulizia. **I contenitori KEY BOX sono dotati di aggancio posteriore per l'impiego pensile su pannelli e carrelli.**



## Boxes KEY BOX

Stackable boxes made of acid-, oil- and solvent-proof thermoplastic material, for use from -40° to +80°C, with frontal stop and flat bottom for inclined planes smooth inner walls for easier cleaning. **The KEY BOX line products has a rear hooking for hanging use on panels and trolley.**



## Bacs KEY BOX

Bacs gerbables produits en matière thermoplastique résistant aux acides, aux huiles et aux solvants ainsi qu'aux températures entre -40° et +80°C, avec des pattes avant et un fond plat pour l'emploi sur des plans inclinés, parois internes lisses pour un nettoyage facile. **Les bacs KEY BOX sont pourvus d'un crochet arrière pour les pendre à des panneaux et des chariots.**



## Contenedores KEY BOX

Contenedores superponibles producidos de material termoplástico resistente a ácidos, aceites y disolventes y a temperaturas de -40° a +80°C, con frenos delanteros y fondo plano para el uso en planos inclinados, paredes internas lisas y para una fácil limpieza. **Los contenedores KEY BOX se han equipado con un gancho trasero para el uso colgado en paneles y carretillas.**



## Behälter KEY BOX

Stapelbare Behälter aus thermoplastischem Material, das beständig gegen Säuren, Öle und Lösungsmittel sowie Temperaturen von -40°C bis +80°C ist, mit Stopperr vorne und ebenem Unterboden für die Verwendung auf geneigten Flächen, glatte Innenwände zur Erleichterung der Reinigung. **Die KEY-BOX-Behälter verfügen über Anhakenrichtung hinten zur hängenden Verwendung an Platten und Wagen.**

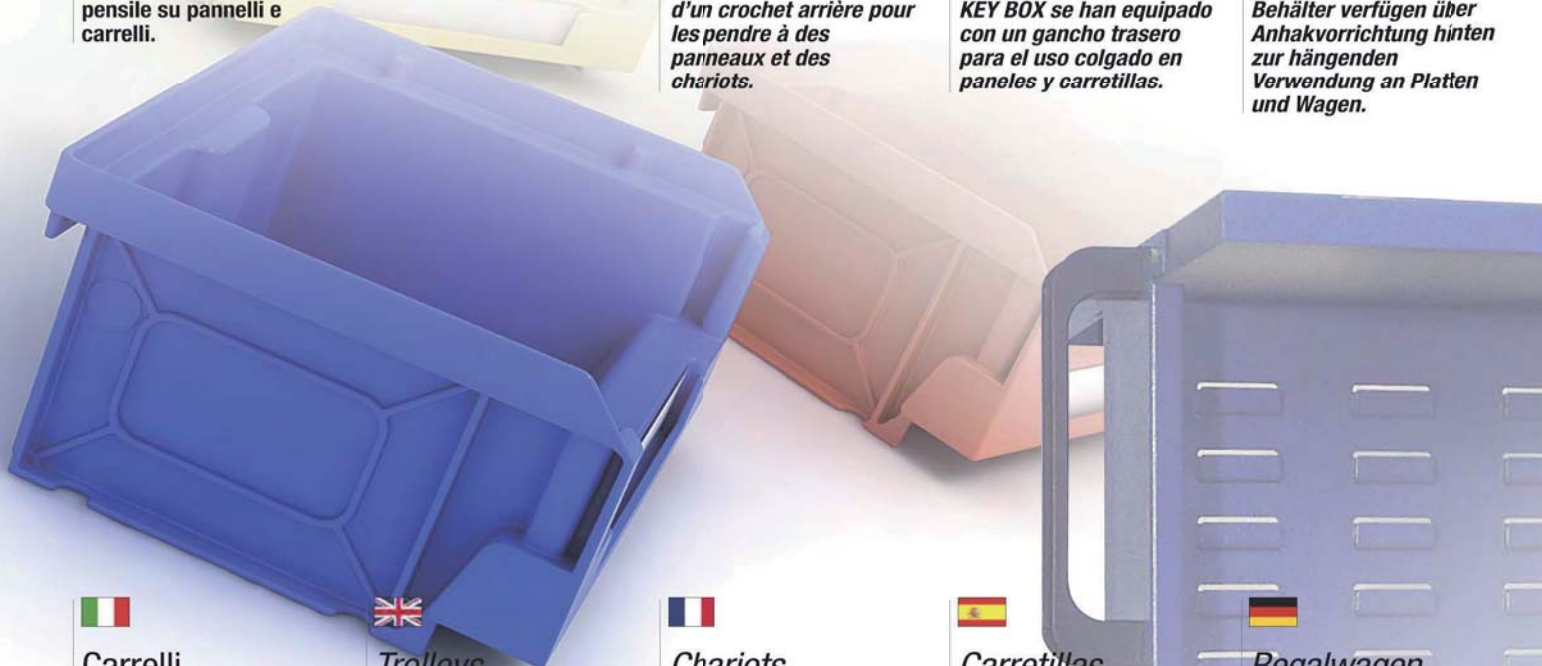

## Carrelli CARRY BOX

Carrelli per porta contenitori della linea **KEY BOX**. L'aspetto antinfornistico di questi carrelli ha caratterizzato la loro progettazione. Robusti e pratici, sono realizzati in lamiera elettrosaldada, verniciati con resina epossidica, dotati di quattro ruote gommatae 2 fisse, 1 piroettante e 1 piroettante con freno. I carrelli della Linea **CARRY BOX** vengono forniti smontati con schema di montaggio e viteria per l'assemblaggio.



## Trolleys CARRY BOX

Trolley for **KEY BOX** holders. Safety and accident prevention have been taken into account in designing these trolley. Strong and handy, epoxy resin-coated electrowelded sheet, four rubber wheels: 2 fixed, 1 pivoting and 1 pivoting with brake. The **CARRY BOX** line trolley are supplied disassembled, with the assembly schema and screws for assembly.



## Chariots CARRY BOX

Chariots porte-bacs de la ligne **KEY BOX**. Ces chariots sont caractérisés par leur aspect visant à prévenir les accidents. Robustes et pratiques, ils son: réalisés en tôle électrosoudée, laqués à résine époxydique, pourvus de quatre roulettes (2 fixes, 1 pivotante et 1 pivotante avec frein). Les chariots de la ligne **CARRY BOX** sont fournis démontés avec le schéma de montage et les vis pour l'assemblage.



## Carretillas CARRY BOX

Carretillas para porta-contenedores de la línea **KEY BOX**. El aspecto de la prevención de accidentes de estas carretillas ha caracterizado su proyecto. Robustas y prácticas, se han realizado de chapa electrosoldada, se han pintado con resina epoxídica y se han equipado con cuatro ruedas engomadas, de las cuales 2 fijas, 1 de viraje y 1 de viraje con freno. Las carretillas de la Línea **CARRY BOX** se entregan desmontadas con esquema de montaje y tornillos para el montaje.



## Regalwagen CARRY BOX

Regalwagen für Behälter der Linie **KEY BOX**. Die Entwicklung dieser Wagen erfolgte in erster Linie unter den Aspekten der Unfallverhütung. Sie sind robust und praktisch, aus elektrisch geschweißtem Blech gefertigt und mit Epoxidharz lackiert, ausgestattet mit vier gummbereiften Rädern, von denen 2-fest sind, 1 drehbar und 1 drehbar mit Bremse bestückt. Die Wagen der Linie **CARRY BOX** werden zerlegt, mit Montageanweisung und dem erforderlichen Schraubenmaterial geliefert.



## Pannelli PANEL BOX

Pannelli pensili per contenitori della linea **KEY BOX**, realizzati in lamiera verniciata con resina epossidica nel colore grigio RAL 7035.



## Panels PANEL BOX

Hanging panels for the **KEY BOX** line, RAL 7035 epoxy resin-coated sheet.



## Panneaux PANEL BOX

Panneaux pour conteneurs de la ligne **KEY BOX**, réalisés en tôle laqués avec résine époxydique Gris RAL 7035.



## Paneles PANEL BOX

Paneles colgantes para contenedores de la línea **KEY BOX**, realizados de chapa pintada con resina epoxídica de color gris RAL 7035.



## Hängeplatten PANEL BOX

Hängeplatten für Behälter der Linie **KEY BOX** aus Blech, lackiert mit Epoxidharz in der Farbe Grau RAL 7035.



Separatore mobile  
Mobile divider  
Séparateur mobile  
Separador móvil

## K 1

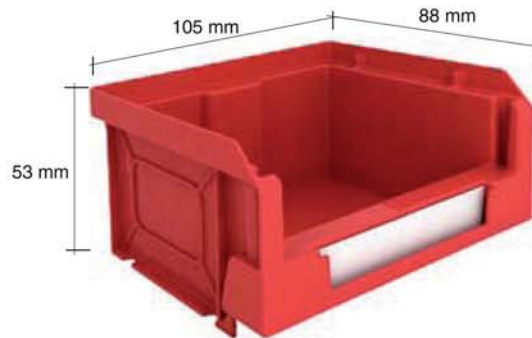

Imballo da pz / Package of pcs /  
Emballage de pcs / Embalaje un /  
Packung mit st: 50

Dimensioni / Dimensions /  
Dimensions / Dimensiones /  
Dimensionen:  
H 53 mm - P 88 mm  
L 105 mm

Visiera trasparente a richiesta.  
Transparent peak on request  
Visière transparent sur demande.  
Visera transparente a petició.

## K 2

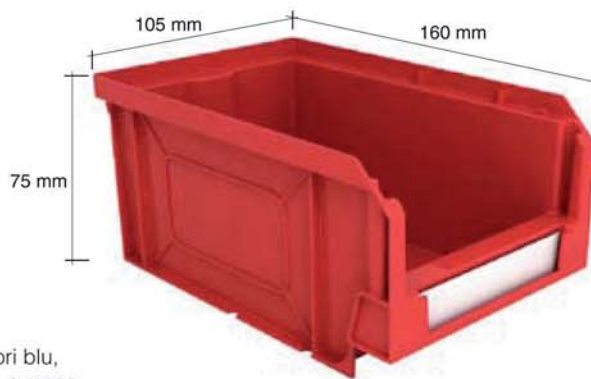

Imballo da pz / Package of pcs /  
Emballage de pcs / Embalaje un /  
Packung mit st: 48

Dimensioni / Dimensions /  
Dimensions / Dimensiones /  
Dimensionen:  
H 75 mm - P 160 mm  
L 105 mm

Visiera trasparente a richiesta.  
Transparent peak on request  
Visière transparent sur demande.  
Visera transparente a petició.



Disponibile nei colori blu,  
giallo, verde, grigio e rosso.

Available in the colors blue,  
yellow, green, grey and red.

Disponibles dans les couleurs  
bleu, jaune, vert, gris et rouge.

Disponibles en los colores azul,  
amarillo, verde, gris y rojo.

Verfügbar in den Farben blau,  
gelb, gruen, grau und rot.

## K 3

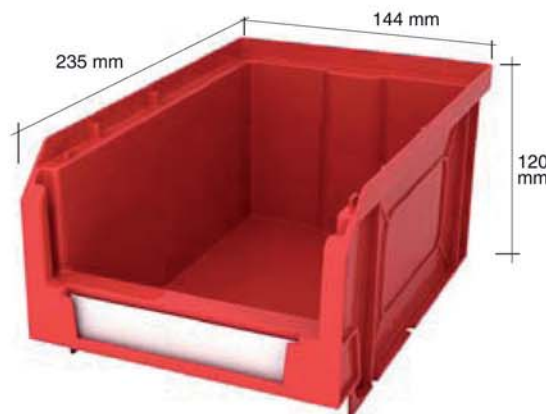

Imballo da pz / Package of pcs /  
Emballage de pcs / Embalaje un /  
Packung mit st: 38

Dimensioni / Dimensions /  
Dimensions / Dimensiones /  
Dimensionen:  
H 120 mm - P 235 mm  
L 144 mm

Visiera trasparente a richiesta.  
Transparent peak on request  
Visière transparent sur demande.  
Visera transparente a petició.

## K 4

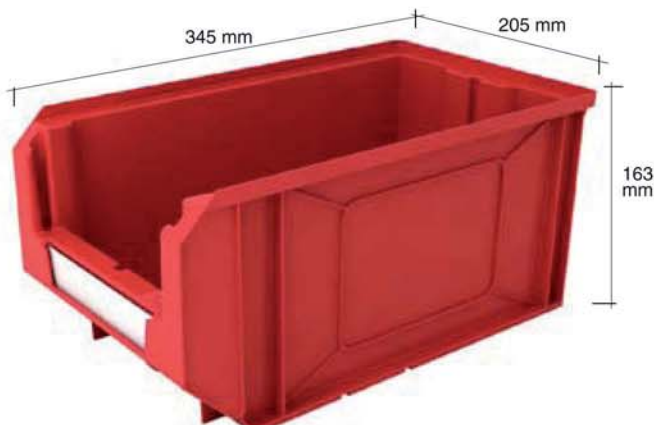

Imballo da pz / Package of pcs /  
Emballage de pcs / Embalaje un /  
Packung mit st: 24

Dimensioni / Dimensions /  
Dimensions / Dimensiones /  
Dimensionen:  
H 163 mm - P 345 mm  
L 205 mm

Visiera trasparente e separatore mobile a richiesta.  
Transparent peak and mobile separator on request  
Visière transparente et séparateur mobile à la demande.  
Visera transparente y separador móvil a petició.



Visiera trasparente  
Transparent peak  
Visière transparente  
Visera transparente  
Transparentes Visier

Imballo da pz / Package of pcs /  
Emballage de pcs / Embalaje un /  
Packung mit st: 8

Dimensioni / Dimensions /  
Dimensions / Dimensiones /  
Dimensionen:  
H 163 mm - P 345 mm  
L 410 mm

Visiera trasparente e 1, 2 o 3 separatori mobili a richiesta.  
Transparent peak and 1, 2 or 3 mobile separators on request  
Visière transparente et 1, 2 ou 3 séparateurs mobiles à la  
demande.  
Visoir transparente y 1, 2 o 3 separadores móviles a solicitud.

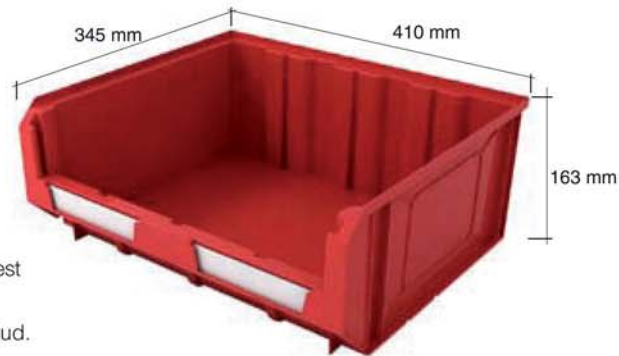

**K 4/D**

Imballo da pz / Package of pcs /  
Emballage de pcs / Embalaje un /  
Packung mit st: 12

Dimensioni / Dimensions /  
Dimensions / Dimensiones /  
Dimensionen:  
H 189 mm - P 485 mm  
L 298 mm

Visiera trasparente e separatore mobile a richiesta.  
Transparent peak and mobile separator on request  
Visière transparente et séparateur mobile à la demande.  
Visera transparente y separador móvil a petición.

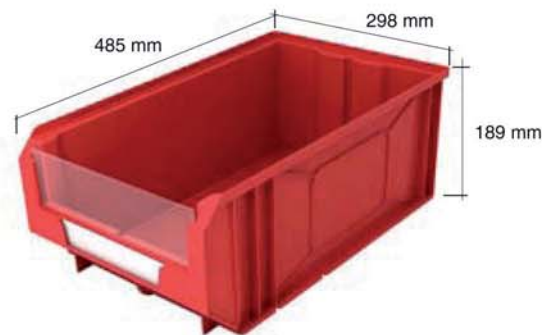

**K 5**

Imballo da pz / Package of pcs /  
Emballage de pcs / Embalaje un /  
Packung mit st: 4

Dimensioni / Dimensions /  
Dimensions / Dimensiones /  
Dimensionen:  
H 250 mm - P 600 mm  
L 372 mm

Visiera trasparente e separatore mobile a richiesta.  
Transparent peak and mobile separator on request  
Visière transparente et séparateur mobile à la demande.  
Visera transparente y separador móvil a petición.

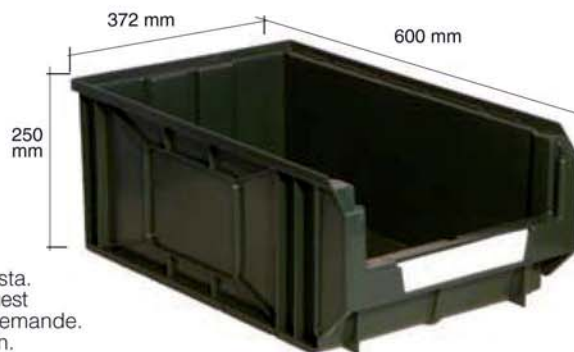

**K 6**



Disponibile nei colori blu e verde.  
Available in the colors blue and green.  
Disponibles dans les couleurs bleu et vert.  
Disponibles en los colores azul y verde.  
Verfügbar in den Farben blau und gruen.

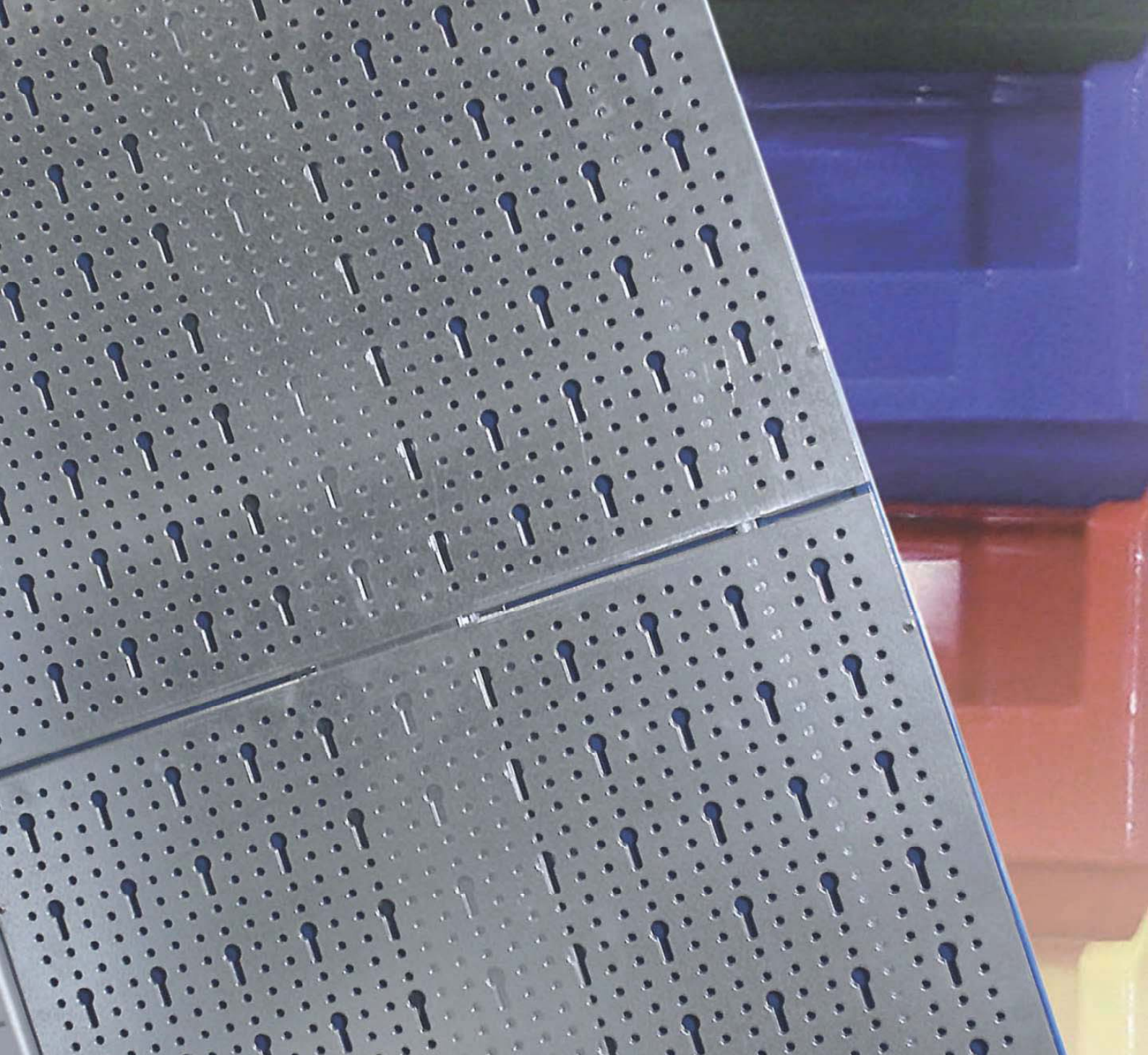

# ARMADI

*Cabinets · Armoires · Armarios · Schränke*

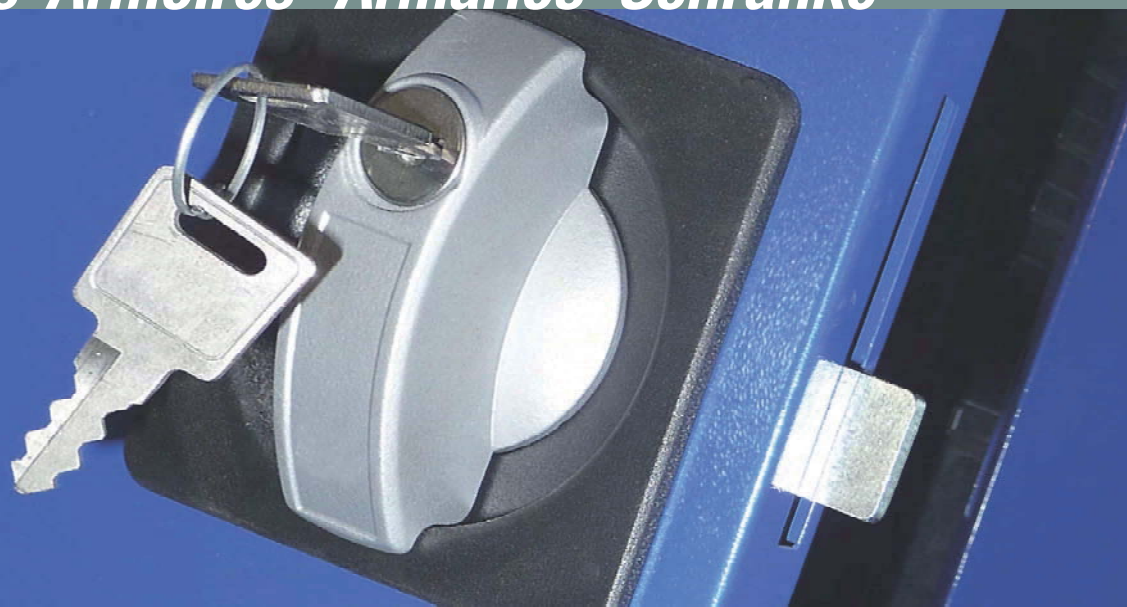



Tutti gli armadi sono forniti con 4 ripiani. A richiesta sono disponibili pannelli porta contenitori da applicare sul fondo e sulle porte.

*Toutes les armoires sont fournies avec 4 tablettes. Sur demande ils sont disponibles plaques porte-bacs à appliquer sur le fond et sur les portes.*

*Todos los armarios son provistos con 4 anaqueles. A petición son disponibles paneles porta contenedores por aplicar sobre el fondo y sobre las puertas.*





## AR 70/27 70/27-P

Armadio / Cabinet / Armoire /  
Armario / Schränk.

Imballo da pz. / Package of pcs. /  
Emballage de pcs. / Embalaje  
un. / Packung mit st: 1

Dimensioni / Dimensions /  
Dimensions / Dimensiones /  
Dimensionen:  
L 700 mm - P 275 mm  
H 1950 mm.

Portata massima consigliata  
armadio / Max. recommended  
load-bearing capacity of the  
cabinets / Portée maximale  
conseillée des armoires /  
Capacidad de carga máxima  
aconsejada para los armarios /  
Maximale Tragfähigkeit der  
Schränk:  
250 kg.

Portata consigliata ripiano /  
Max. recommended load-  
bearing capacity of the ledges /  
Portée maximale conseillée  
des tablettes / Capacidad de  
carga máxima aconsejada de  
los anaqueles / Maximale  
Tragfähigkeit der  
Einlegebretter:  
30 kg.

**N.B.:**  
Gli armadi con profondità 275 mm  
devono essere fissati a muro con l'impiego di staffe  
fornite di serie.

*The 275 mm deep cabinets must be anchored  
to the walls using the brackets included in the supply.*

*Les armoires de 275 mm de profondeur doivent être  
fixées au mur à l'aide des étriers fournis.*

*Los armarios con profundidad 275 mm se deben  
fijar en pared con el uso de estribos entregados de serie.*

*Schränke mit Tiefe 275 mm müssen mit Hilfe  
der serienmäßig mitgelieferten Bügel an der Wand  
befestigt werden.*

1950 mm

700 mm

275 mm

### AR 70/27A, 70/27A-P

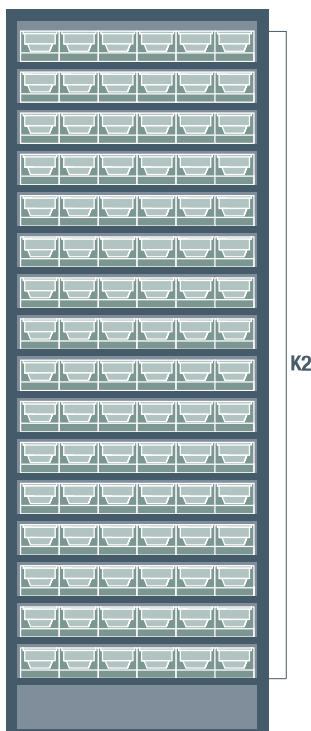

Dotazione / Equipment / Dotation /  
Equipamiento / Dotation:

KEY BOX: K2 n. 96

Ripiani / Ledges / Tablettes / Anaqueles / Bretter: n. 16

### AR 70/27B, 70/27B-P

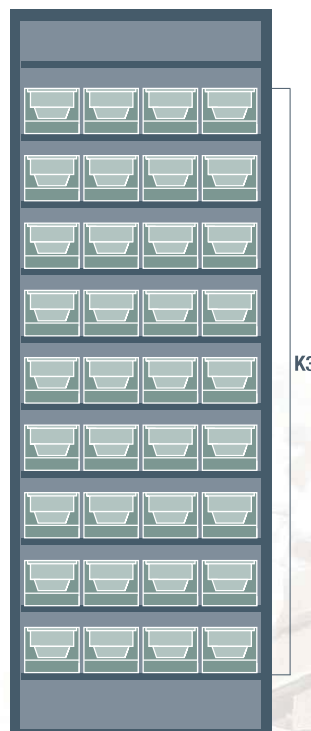

Dotazione / Equipment / Dotation /  
Equipamiento / Dotation:

KEY BOX: K3 n. 36

Ripiani / Ledges / Tablettes / Anaqueles / Bretter: n. 10

### AR 70/27C, 70/27C-P

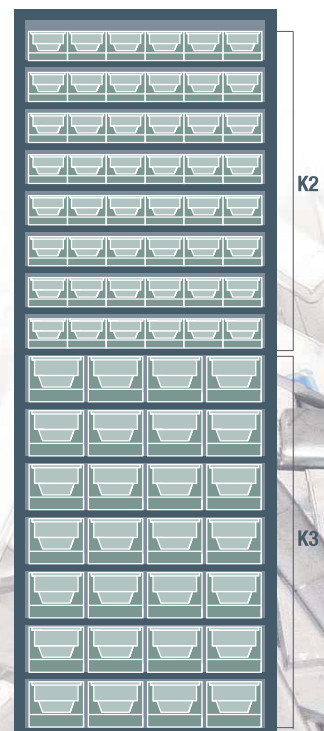

Dotazione / Equipment / Dotation /  
Equipamiento / Dotation:

KEY BOX: K2 n. 48 - K3 n. 28

Ripiani / Ledges / Tablettes / Anaqueles / Bretter: n. 14



## AR 70/52 70/52-P

Armadio / Cabinet / Armoire /  
Armario / Schränk.

Imballo da pz. / Package of pcs. /  
Emballage de pcs. / Embalaje  
un. / Packung mit st: 1

Dimensioni / Dimensions /  
Dimensions / Dimensiones /  
Dimensionen:  
L 700 mm - P 520 mm  
H 1950 mm.

Portata massima consigliata  
armadio / Max. recommended  
load-bearing capacity of the  
cabinets / Portée maximale  
conseillée des armoires /  
Capacidad de carga máxima  
aconsejada para los armarios /  
Maximale Tragfähigkeit der  
Schränk:  
300 kg.

Portata consigliata ripiani /  
Max. recommended load-  
bearing capacity of the ledges  
/ Portée maximale conseillée  
des tablettes / Capacidad de  
carga máxima aconsejada de  
los anaqueles / Maximale  
Tragfähigkeit der  
Einlegebretter:  
40 kg.

1950 mm

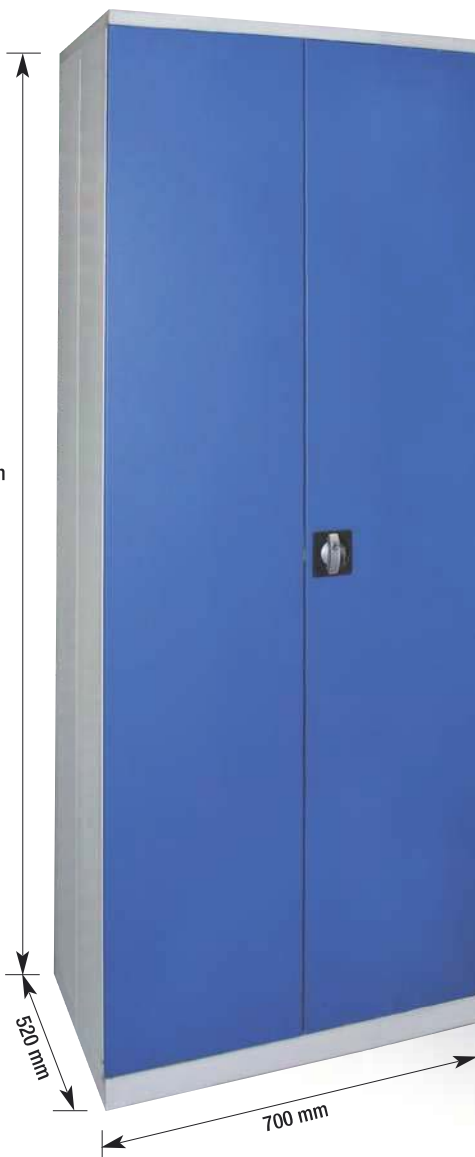

### AR 70/52A, 70/52A-P

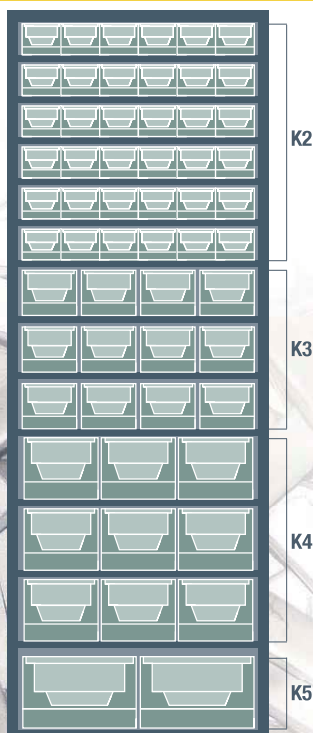

Dotazione / Equipment / Dotation /  
Equipamiento / Dotation:

KEY BOX: K2 n. 36 - K3 n. 12 - K4 n. 9 - K5 n. 2  
Ripiani / Ledges / Tablettes / Anaqueles / Bretter: n. 16

### AR 70/52B, 70/52B-P

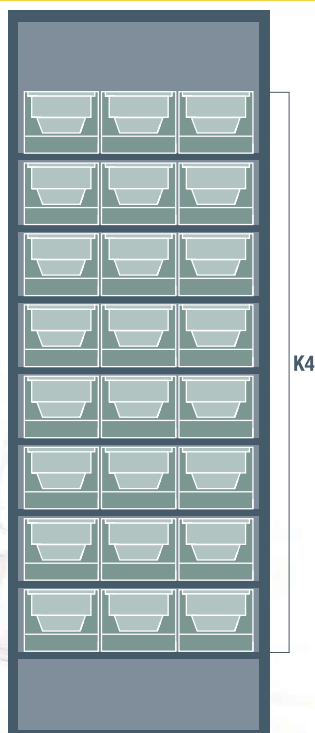

Dotazione / Equipment / Dotation /  
Equipamiento / Dotation:

KEY BOX: K4 n. 24  
Ripiani / Ledges / Tablettes / Anaqueles / Bretter: n. 16

### AR 70/52C, 70/52C-P

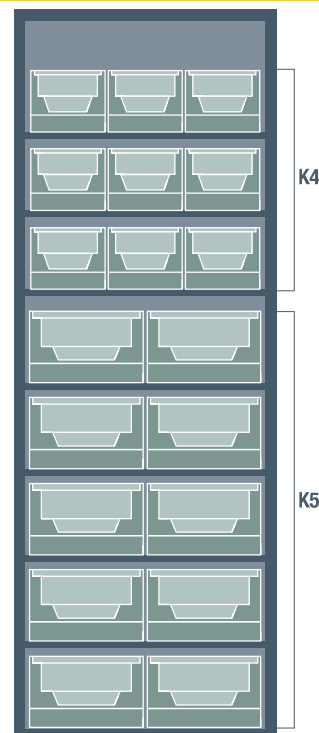

Dotazione / Equipment / Dotation /  
Equipamiento / Dotation:

KEY BOX: K4 n. 9 - K5 n. 10  
Ripiani / Ledges / Tablettes / Anaqueles / Bretter: n. 14





## AR 100/27 100/27-P

Armadio / Cabinet / Armoire /  
Armario / Schränk.

Imballo da pz. / Package of pcs. /  
Emballage de pcs. / Embalaje  
un. / Packung mit st: 1

Dimensioni / Dimensions /  
Dimensions / Dimensiones /  
Dimensionen:  
L 1050 mm / P 275 mm /  
H 1950 mm.

Portata massima consigliata  
armadio / Max. recommended  
load-bearing capacity of the  
cabinets / Portée maximale  
conseillée des armoires /  
Capacidad de carga máxima  
aconsejada para los armarios /  
Maximale Tragfähigkeit der  
Schränk:  
300 kg.

Portata consigliata ripiano /  
Max. recommended load-  
bearing capacity of the ledges /  
Portée maximale conseillée  
des tablettes / Capacidad de  
carga máxima aconsejada de  
los anaqueles / Maximale  
Tragfähigkeit der  
Einlegebretter:  
40 kg.



### N.B.:

Gli armadi con profondità 275 mm  
devono essere fissati a muro con  
l'impiego di staffe fornite di serie.

*The 275 mm deep cabinets must  
be anchored to the walls using the  
brackets included in the supply.*

*Les armoires de 275 mm de  
profondeur doivent être fixées au  
mur à l'aide des étriers fournies.*

*Los armarios con profundidad  
275 mm se deben fijar  
en pared con el uso de estribos  
entregados de serie.*

*Schränke mit Tiefe 275 mm müssen  
mit Hilfe der serienmäßig  
mitgelieferten Bügel an der Wand  
befestigt werden.*

### AR 100/27A, 100/27A-P

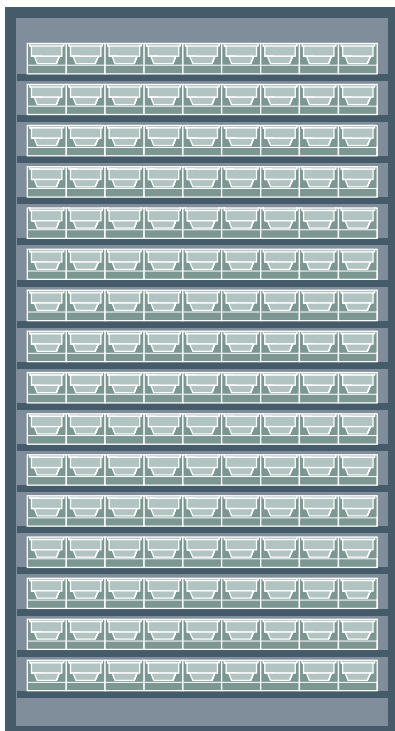

Dotazione / Equipment / Dotation /  
Equipamiento / Dotation:

KEY BOX: K2 n. 144

Ripiani / Ledges / Tablettes / Anaqueles / Bretter: n. 16

### AR 100/27B, 100/27A-P



Dotazione / Equipment / Dotation /  
Equipamiento / Dotation:

KEY BOX: K2 n. 90 - K3 n. 36

Ripiani / Ledges / Tablettes / Anaqueles / Bretter: n. 15

### AR 100/27B, 100/27A-P



Dotazione / Equipment / Dotation /  
Equipamiento / Dotation:

KEY BOX: K3 n. 72

Ripiani / Ledges / Tablettes / Anaqueles / Bretter: n. 12



## AR 100/52 100/52-P

Armadio / Cabinet / Armoire /  
Armario / Schränk.

Imballo da pz. / Package of pcs. /  
Emballage de pcs. / Embalaje  
un. / Packung mit st: 1

Dimensioni / Dimensions /  
Dimensions / Dimensiones /  
Dimensionen:  
L 1050 mm / P 520 mm /  
H 1950 mm.

Portata massima consigliata  
armadio / Max. recommended  
load-bearing capacity of the  
cabinets / Portée maximale  
conseillée des armoires /  
Capacidad de carga máxima  
aconsejada para los armarios /  
Maximale Tragfähigkeit  
der Schränke:  
500 kg.

Portata consigliata ripiano /  
Max. recommended load-  
bearing capacity of the ledges /  
Portée maximale conseillée des  
tablettes / Capacidad de carga  
máxima aconsejada de los  
anaqueles / Maximale  
Tragfähigkeit der  
Einlegebretter:  
40 kg.



### AR 100/52A, 100/52A-P

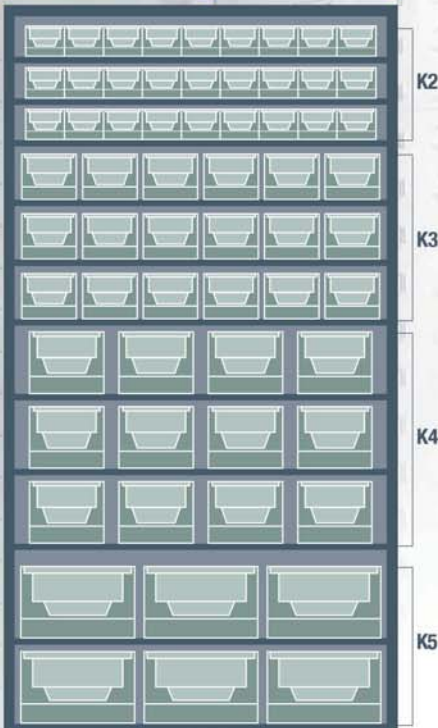

Dotazione / Equipment / Dotation /  
Equipamiento / Dotation:

KEY BOX: K2 n. 27 - K3 n. 18 - K4 n. 12 - K5 n. 6  
Ripiani / Ledges / Tablettes / Anaqueles / Bretter: n. 15

### AR 100/52B, 100/52B-P

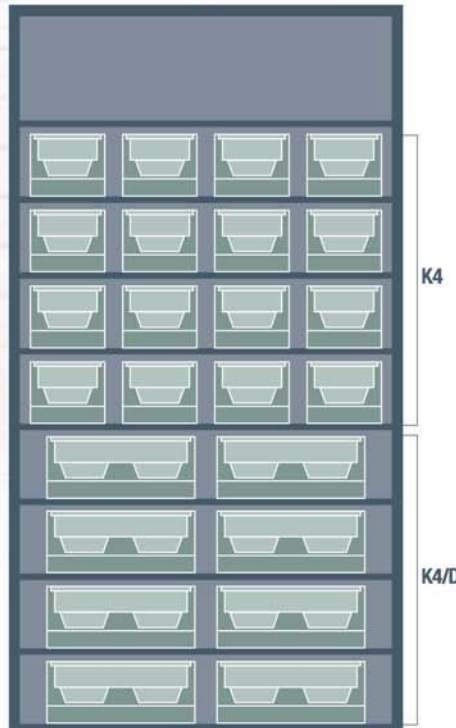

Dotazione / Equipment / Dotation /  
Equipamiento / Dotation:

KEY BOX: K4 n. 16 - K4/D n. 8  
Ripiani / Ledges / Tablettes / Anaqueles / Bretter: n. 16

### AR 100/52C, 100/52C-P

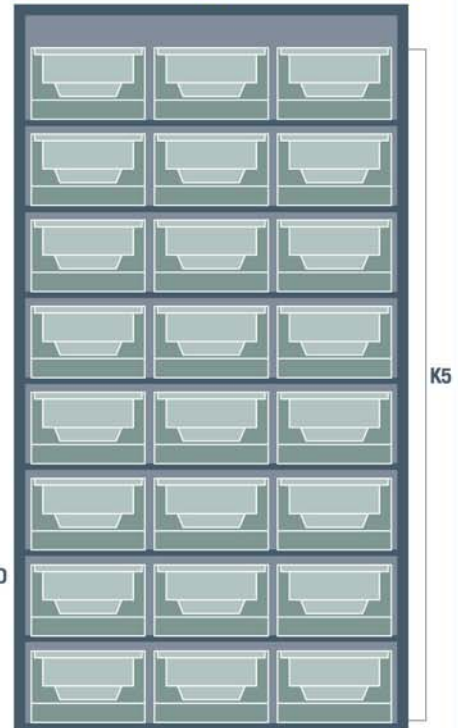

Dotazione / Equipment / Dotation /  
Equipamiento / Dotation:

KEY BOX: K5 n. 24  
Ripiani / Ledges / Tablettes / Anaqueles / Bretter: n. 14

### AR 70/27-P D

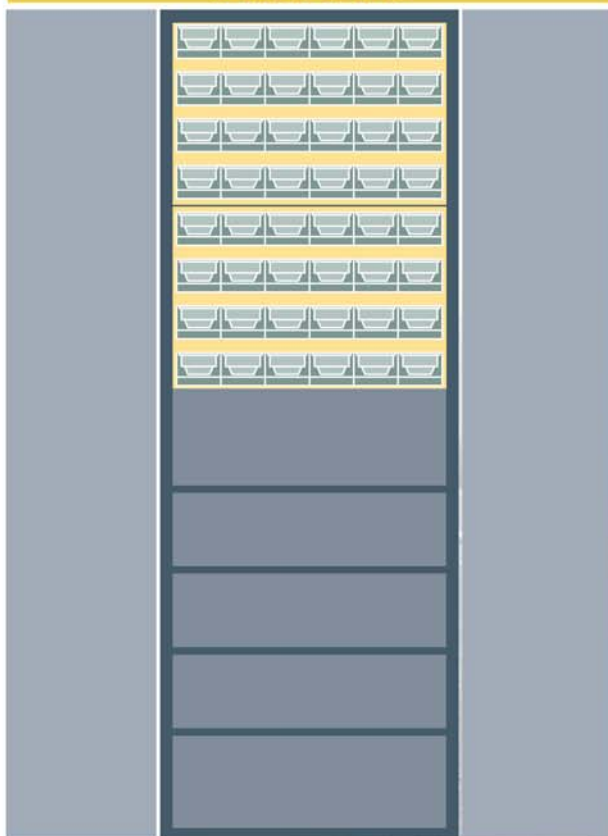

KEY BOX: K2 n. 48  
 Ripiani / Ledges / Tablettes / Anaqueles / Bretter: n. 4  
 Pannelli fondo / Fund panel / Panneaux pour le fonde / Paneles fundo / n. 2

### AR 70/52-P F

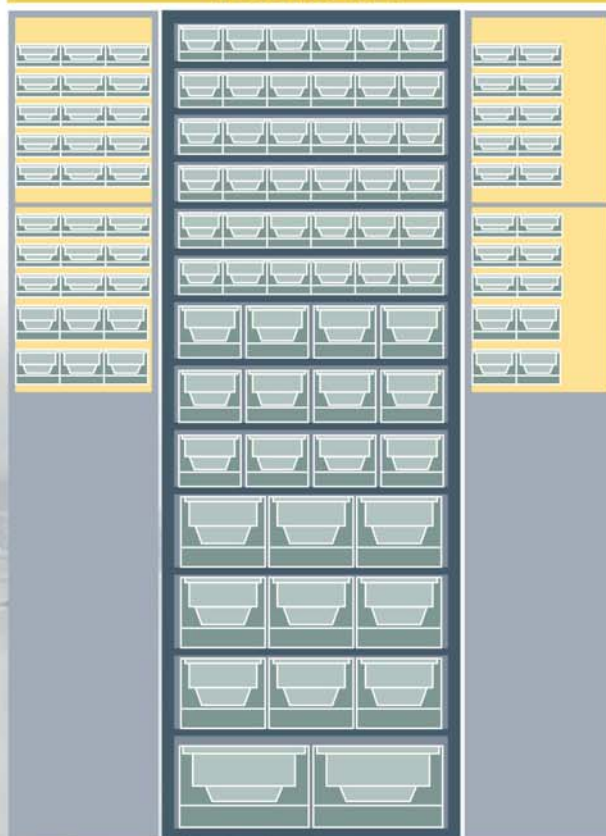

KEY BOX: K1 n. 40 - K2 n. 46 - K3 n. 12 - K4 n. 9 - K5 n. 2  
 Ripiani / Ledges / Tablettes / Anaqueles / Bretter: n. 16  
 Pannelli porte / Door panels / Panneaux pour le portes /  
 Paneles por puertas / Türenpanel: n. 4

### AR 70/27-P E

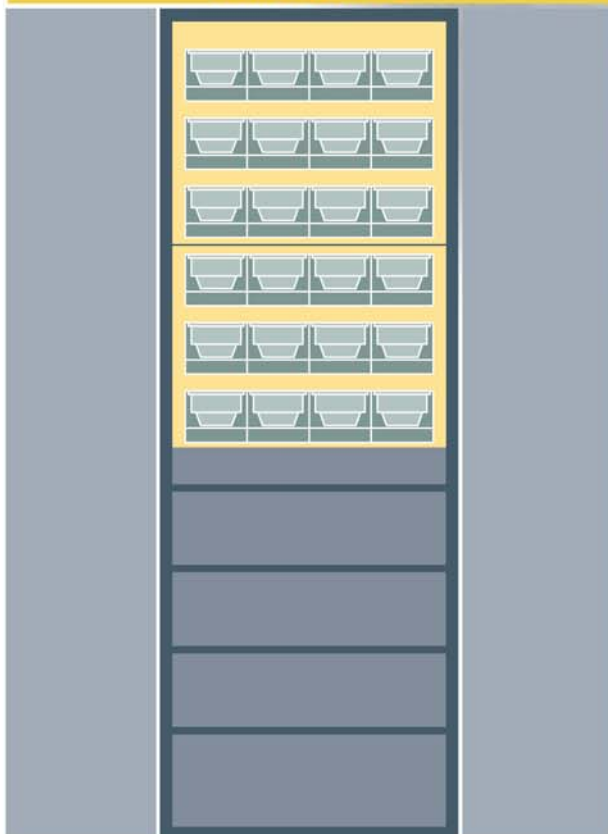

KEY BOX: K3 n. 24  
 Ripiani / Ledges / Tablettes / Anaqueles / Bretter: n. 4  
 Pannelli fondo / Fund panel / Panneaux pour le fonde / Paneles fundo / n. 2

### AR 70/52-P G

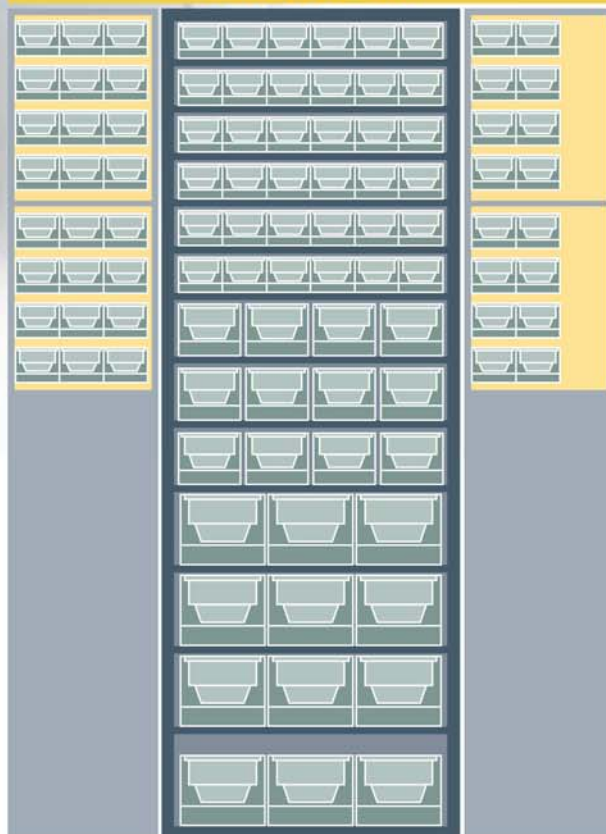

KEY BOX: K2 n. 86 - K3 n. 12 - K12  
 Ripiani / Ledges / Tablettes / Anaqueles / Bretter: n. 16  
 Pannelli porte / Door panels / Panneaux pour le portes /  
 Paneles por puertas / Türenpanel: n. 4

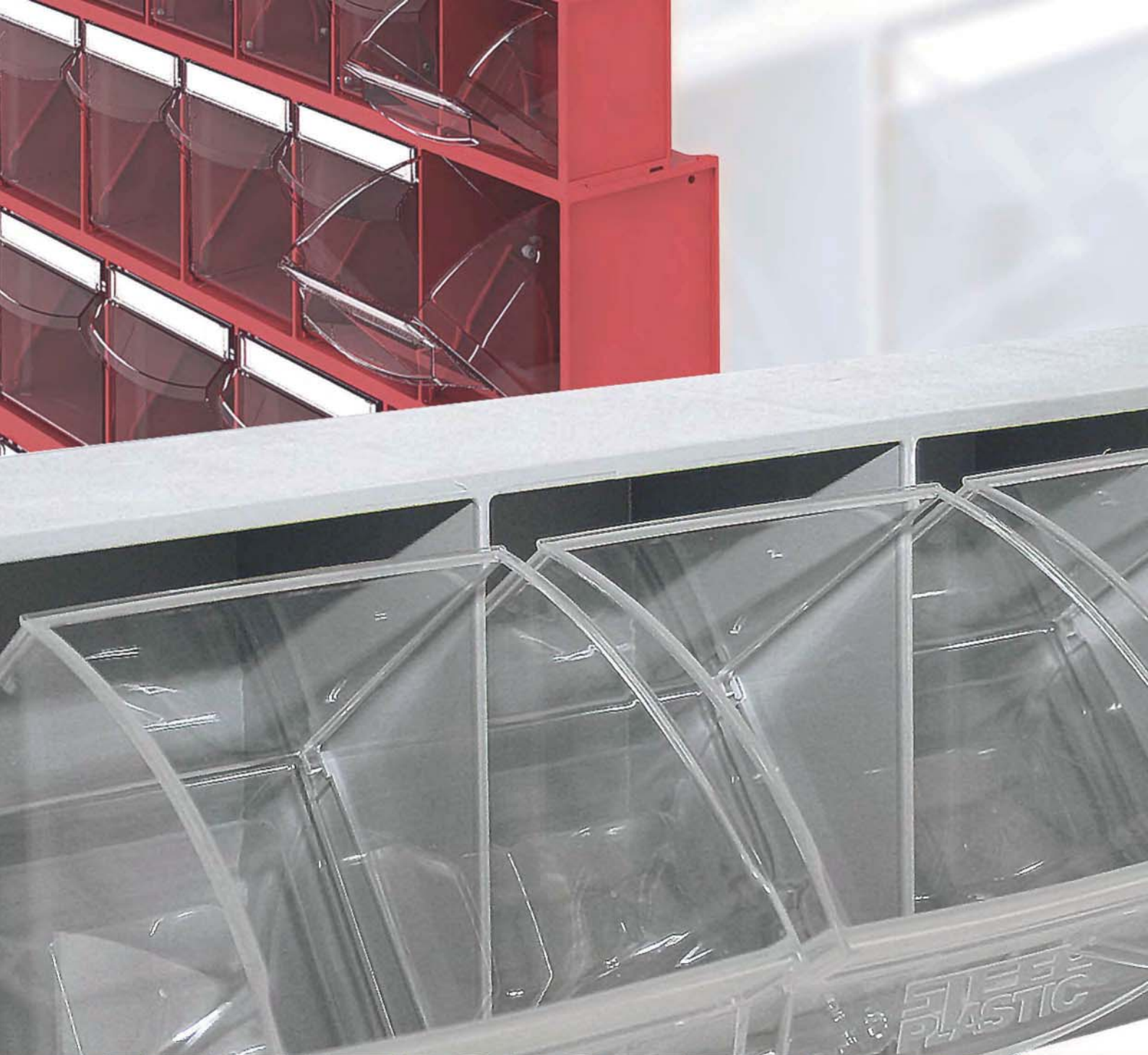

# MULTISISTEM

*Multibox · Draw storage cabinets · Blocs à tiroirs · Schubladenkästen*





## MB 9

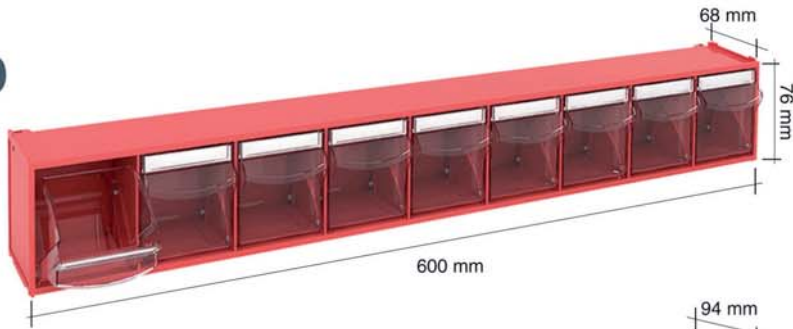

### MB 9

Imballo da pz. / Package of pcs / Emballage de pcs / Embalaje un / Packung mit st: 1

Dimensioni / Dimensions /  
Dimensions / Dimensiones /  
Dimensionen: L 600 mm - P 68 mm - H 76 mm.

Disponibile nei colori grigio e rosso  
Available in the colors grey and red  
Disponibles dans les couleurs gris et rouge  
Disponibles en los colores gris y rojo

## MB 6

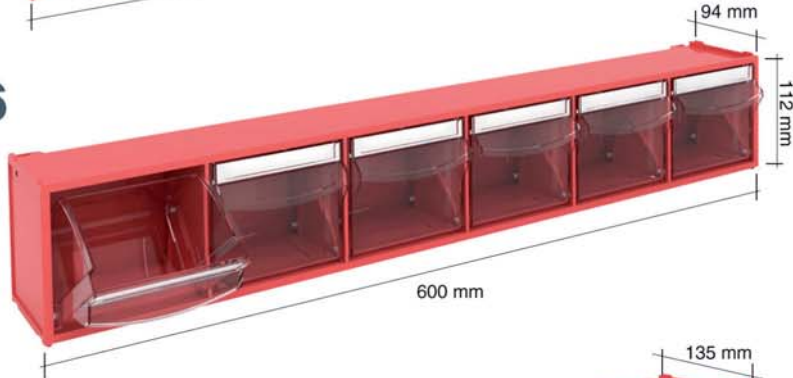

### MB 6

Imballo da pz. / Package of pcs /  
Emballage de pcs / Embalaje un /  
Packung mit st: 1

Dimensioni / Dimensions /  
Dimensions / Dimensiones /  
Dimensionen: L 600 mm - P 94 mm - H 112 mm.

Disponibile nei colori grigio e rosso  
Available in the colors grey and red  
Disponibles dans les couleurs gris et rouge  
Disponibles en los colores gris y rojo

## MB 5

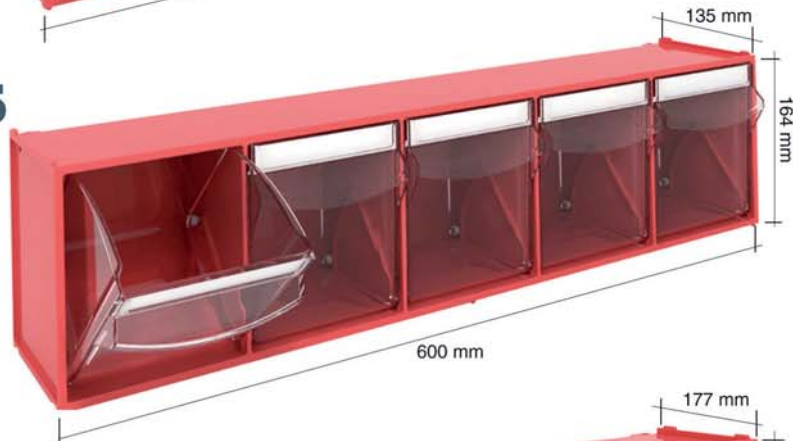

### MB 5

Imballo da pz. / Package of pcs /  
Emballage de pcs / Embalaje un /  
Packung mit st: 1

Dimensioni / Dimensions /  
Dimensions / Dimensiones /  
Dimensionen: L 600 mm - P 135 mm - H 164 mm.

Disponibile nei colori grigio e rosso  
Available in the colors grey and red  
Disponibles dans les couleurs gris et rouge  
Disponibles en los colores gris y rojo

## MB 4



### MB 4

Imballo da pz. / Package of pcs /  
Emballage de pcs / Embalaje un /  
Packung mit st: 1

Dimensioni / Dimensions /  
Dimensions / Dimensiones /  
Dimensionen: L 600 mm - P 177 mm - H 206 mm.

Disponibile nei colori grigio e rosso  
Available in the colors grey and red  
Disponibles dans les couleurs gris et rouge  
Disponibles en los colores gris y rojo

## MB 3

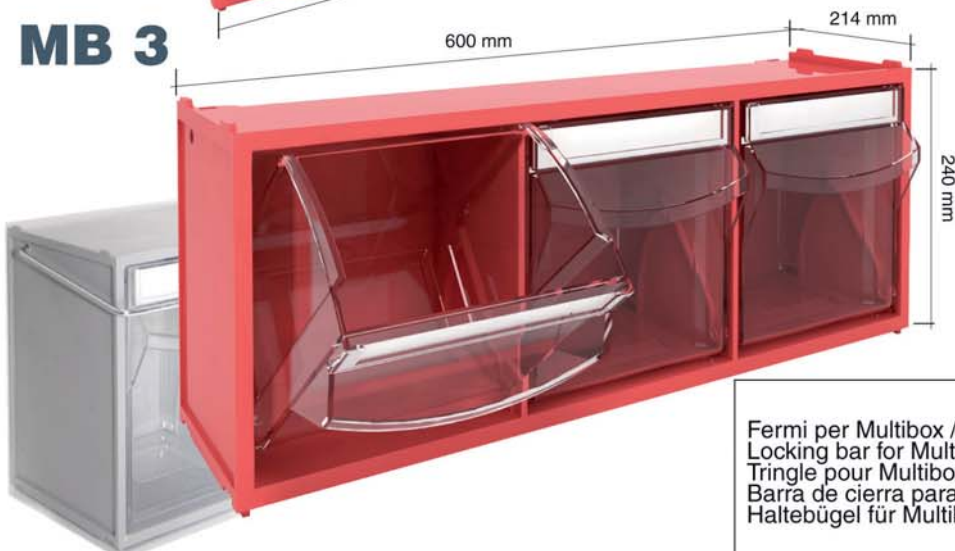

### MB 3

Imballo da pz. / Package of pcs /  
Emballage de pcs / Embalaje un /  
Packung mit st: 1

Dimensioni / Dimensions /  
Dimensions / Dimensiones /  
Dimensionen: L 600 mm - P 214 mm - H 240 mm.

Disponibile nei colori grigio e rosso  
Available in the colors grey and red  
Disponibles dans les couleurs gris et rouge  
Disponibles en los colores gris y rojo

Fermi per Multibox /  
Locking bar for Multibox /  
Tringle pour Multibox /  
Barra de cierra para Multibox /  
Haltebügel für Multibox



# S 500



Telaio da banco / Benchframe / Stand de table /  
Bastidor de banco / Bankhalter

Imballo da pz. / Package of pcs / Emballage de pcs /  
Embalaje un / Packung mit st: 1

Dimensioni / Dimensions / Dimensions / Dimensiones /  
Dimensionen: L 605 mm - P 150 mm - H 500 mm

Colore / Farben / Color / Couleur / Color: RAL 7035

Disponibile con o senza kit MULTIBOX  
Available with or without kit MULTIBOX  
Disponible avec ou sans kit MULTIBOX  
Disponibile con o sin kit MULTIBOX  
Verfügbar mit oder ohne KIT MULTIBOX

Totale numero cassetti / Total number of drawers /  
Número total des tirois / Número total de caiones /  
Anzahl Kippschubladen : 24

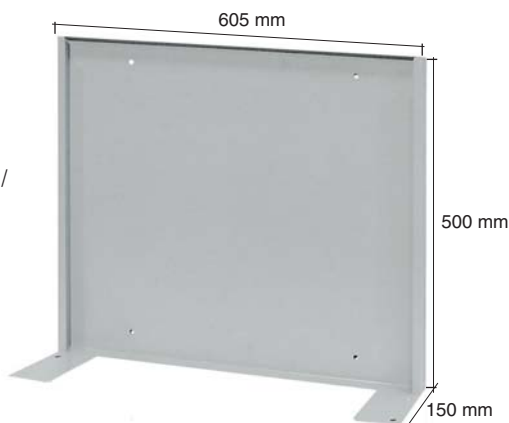

Dotazione / Equipment / Dotation / Equipamiento / Dotation: MB 9 n. 1 - MB 6 n. 1 - MB 5 n. 1 - MB 4 n. 1

# S 510



Telaio da muro / Wallframe /  
Stand mural / Bastidor de pared /  
Wandhalter

Imballo da pz. / Package of pcs / Emballage de pcs /  
Embalaje un / Packung mit st: 1

Dimensioni / Dimensions / Dimensions / Dimensiones /  
Dimensionen: L 605 mm - P 40 mm - H 1000 mm

Colore / Farben / Color / Couleur / Color: RAL 7035

Disponibile con o senza kit MULTIBOX  
Available with or without kit MULTIBOX  
Disponible avec ou sans kit MULTIBOX  
Disponibile con o sin kit MULTIBOX  
Verfügbar mit oder ohne KIT MULTIBOX

Totale numero cassetti / Total number of drawers  
Número total des tirois / Número total de caiones  
Anzahl Kippschubladen: 41

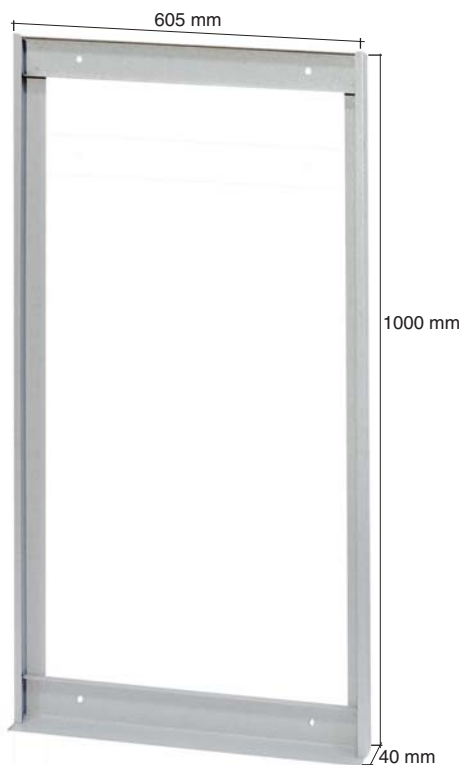

Dotazione / Equipment / Dotation / Equipamiento / Dotation: MB 9 n. 2 - MB 6 n. 1 - MB 5 n. 2 - MB 4 n. 1 - MB 3 n. 1



## Cassettiere MULTIBOX

Cassettiere componibili realizzate in resina termoplastica resistente agli urti, dotate di cassetti estraibili basculanti con maniglia ergonomica di forma arrotondata e porta etichette di grandi dimensioni integrato nel cassetto. Grazie alle guide presenti sulla parte posteriore dell'involucro portacassetti, tutte le cassettiere MULTIBOX possono essere utilizzate anche a muro per mezzo di viti e su numerosi supporti metallici al fine di realizzare pareti attrezzate di diverse dimensioni. Le cassettiere sono disponibili in cinque differenti dimensioni.



## Drawer storage cabinets MULTIBOX

Modular drawer storage cabinets made of shockproof thermoplastic resin, with tilting pull-open drawers, rounded ergonomic handle and large label holder. Thanks to the guides on the back of the drawer-holding casing, all the MULTIBOX drawer storage cabinets can also be wall-mounted by means of screws and metal supports to create modular equipped walls. The drawer storage cabinets are available in five different sizes.



## Blocs à tiroirs MULTIBOX

Blocs à tiroirs par éléments réalisés en résine thermoplastique résistant aux chocs, pourvus de tiroirs extractibles basculant avec une poignée ergonomique arrondie et un porte-étiquette de grande taille intégré dans le tiroir. Grâce aux coulisses présentes sur la partie arrière des blocs portetiroirs, tous les meubles à tiroirs MULTIBOX peuvent être fixés sur un mur à l'aide des vis et sur de nombreux supports métalliques pour réaliser des parois équipées de différentes tailles. Les blocs à tiroirs sont disponibles en cinq différentes dimensions.



## Cajoneras MULTIBOX

Cajoneras componibles realizadas de resina termoplástica resistente a los golpes, equipadas con cajones extraíbles oscilantes, con manilla ergonómica de forma redondeada y portaetiquetas de grandes dimensiones integrado en el cajón. Gracias a las guías presentes en la parte trasera de la envoltura portacajones, todas las cajoneras MULTIBOX se pueden utilizar también en pared por medio de tornillos y en varios soportes metálicos, con el fin de realizar paredes equipadas de varias dimensiones. Las cajoneras están disponibles en cinco diferentes dimensiones.







## Schubladenkästen MULTIBOX

Zusammenstellbare Schubladenkästen aus stoßfestem, thermoplastischem Harz, ausgestattet mit herausziehbaren Kippschubladen mit ergonomischem Griff in abgerundeter Form und großzügigem an der Schublade eingebautem Etikettenschild. Dank der lenkschiene an der Rückwand des Kastengehäuses können alle MULTIBOX - Schubladenkästen auch mit Hilfe von Schrauben und zahlreichen metallischen Halterungsteilen an der Wand befestigt werden, sodass Wandausstattungen unterschiedlicher Größe geschaffen werden können. Die Schubladenkästen sind in fünf unterschiedlichen Größen erhältlich.

## S 514

 Telaio con base / Frame with base / Stand avec base / Bastidor con base / Standregale.

 Imballo da pz. / Package of pcs / Emballage de pcs / Embalaje un / Packung mit st: 1

   Dimensioni / Dimensions / Dimensions / Dimensiones / Dimensionen: L 605 mm - P 300 mm - H 1400 mm

 Colore / Farben / Color / Couleur / Color: RAL 7035  
Disponibile con o senza kit MULTIBOX /  
Available with or without kit MULTIBOX /  
Disponible avec ou sans kit MULTIBOX /  
Disponibile con o sin kit MULTIBOX /  
Verfügbar mit oder ohne kit MULTIBOX

Dotazione / Equipment / Dotation / Equipamiento / Dotation:  
MB 9 n. 1 - MB 6 n. 3 - MB 5 n. 2 - MB 4 n. 2 - MB 3 n. 1



Totale numero cassetti / Total number of drawers / Numéro total des tiroirs /  
Número total de caiones / Anzahl Kippschubladen: 48



## S 516



 Telaio con base / Frame with base / Stand avec base / Bastidor con base / Standregale.

  Imballo da pz. / Package of pcs / Emballage de pcs / Embalaje un / Packung mit st: 1

  Dimensioni / Dimensions / Dimensions / Dimensiones / Dimensionen: S 518: L 605 mm - P 300 mm - H 1850 mm

 Colore / Farben / Color / Couleur / Color: RAL 7035

Disponibile con o senza kit MULTIBOX /  
Available with or without kit MULTIBOX /  
Disponible avec ou sans kit MULTIBOX /  
Disponibile con o sin kit MULTIBOX /  
Verfügbar mit oder ohne kit MULTIBOX

Dotazione / Equipment / Dotation / Equipamiento / Dotation:  
MB 9 n. 2 - MB 6 n. 3 - MB 5 n. 3 - MB 4 n. 2 - MB 3 n. 1

Totale numero cassetti / Total number of drawers / Numéro total des tiroirs /  
Número total de caiones / Anzahl Kippschubladen: 62

## S 518

 Telaio con base / Frame with base / Stand avec base / Bastidor con base / Standregale.

 Imballo da pz. / Package of pcs / Emballage de pcs / Embalaje un / Packung mit st: 1

   Dimensioni / Dimensions / Dimensions / Dimensiones / Dimensionen: S 518: L 605 mm - P 300 mm - H 1850 mm

 Colore / Farben / Color / Couleur / Color: RAL 7035

Disponibile con o senza kit MULTIBOX /  
Available with or without kit MULTIBOX /  
Disponible avec ou sans kit MULTIBOX /  
Disponibile con o sin kit MULTIBOX /  
Verfügbar mit oder ohne kit MULTIBOX

Dotazione / Equipment / Dotation / Equipamiento / Dotation:  
MB 9 n. 2 - MB 6 n. 3 - MB 5 n. 3 - MB 4 n. 2 - MB 3 n. 2

Totale numero cassetti / Total number of drawers / Numéro total des tiroirs /  
Número total de caiones / Anzahl Kippschubladen: 65

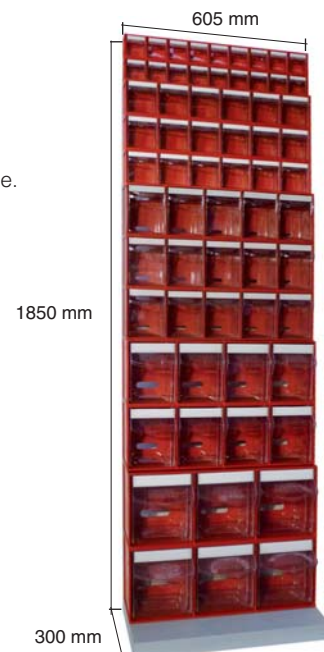

# S 520



Scaffale / Shelf / Étagère / Estanteria / Regal.

Imballo da pz. / Package of pcs / Emballage de pcs /

Embalaje un / Packung mit st: 1

Dimensioni / Dimensions / Dimensions / Dimensiones /

Dimensionen: L 665 mm - P 250 mm - H 2000 mm

Colore / Farben / Color / Couleur / Color: RAL 7035

Fornito montato / Supplied assembled / Fourni monté /

Se abastece ya montado / Lieferung fertig montiert

Dotazione / Equipment / Dotation / Equipamiento /

Dotation: MB 6 n. 4 - MB 5 n. 5 - MB 4 n. 3

Totale numero cassetti / Total number of drawers /

Numéro total des tiroirs / Número total de cajones /

Anzahl Kippschubladen: 61



## Telai STAND

Espositori da banco, da parete e con base di appoggio a terra realizzati in lamiera elettrosaldata e verniciati a forno con polvere epossidica di colore Grigio Ral 7035.

Disponibili con kit standard di cassettiere **MULTIBOX**.



## Stand frames STAND

Bench, wall-mount and selfstanding display stands, made of RAL 7035 grey epoxy powder-painted electrowelded sheet.

Available with the standard kit of the **MULTIBOX** drawer storage cabinets.



## Stands STAND

Présentoirs de comptoirs, muraux et avec une base d'appui au sol, réalisés en tôle électro-soudée et laqués au four à la poudre époxydique Gris RAL 7035.

Disponibles avec un kit standard de blocs à tiroirs **MULTIBOX**.



## Expositores STAND

Expositores para mostrador, para pared y con base de apoyo en el suelo, realizados de chapa electrosoldada y pintados en horno con polvo epoxidico de color gris RAL 7035.

Están disponibles unos kit estándar de cajoneras **MULTIBOX**.



## Ständer STAND

Ausstellungsständer für Ladentische oder zur Wandmontage mit Unterteil zum Aufstellen am Boden aus elektrisch geschweißtem und mit Epoxidpulver einbrennlackiertem Blech in der Farbe Grau RAL 7035. Verfügbar mit Standardbausatz für **MULTIBOX** - Schubladenkästen.



# SL 601



Armadio / Cabinet / Armoire / Armario / Schränk.

Imballo da pz. / Package of pcs /  
Emballage de pcs / Embalaje un /  
Packung mit st: 1

Dimensioni / Dimensions /  
Dimensions / Dimensiones / Dimensionen:  
L 1270 mm - P 400 mm - H 1965 mm

Colore / Farben / Color / Couleur / Color: RAL 7035

Portata singolo pannello / Capacity  
of each panel / Portée de chaque  
panneau / Capacidad cada panel /  
Tragfähigkeit je schiebewand:  
Kg. 150

Fornito smontato /  
Supplied in kit form /  
Fournie démontée /  
Consignado desmontado /  
Wird zerlegt geliefert



# SL 601 STANDARD

Dotazione / Equipment /  
Dotation / Equipamiento /  
Dotation:

Fondo / Fund / Fond /  
Fondo / Boden:  
MB 5 n. 22

Pannello / Panel /  
Panneau / Panel /  
Schiebewand :  
MB 6 n. 16

Totale numero cassetti /  
Total number of drawers /  
Numéro total des tiroirs /  
Número total de caiones /  
Anzahl Kippschubladen:  
n. 206

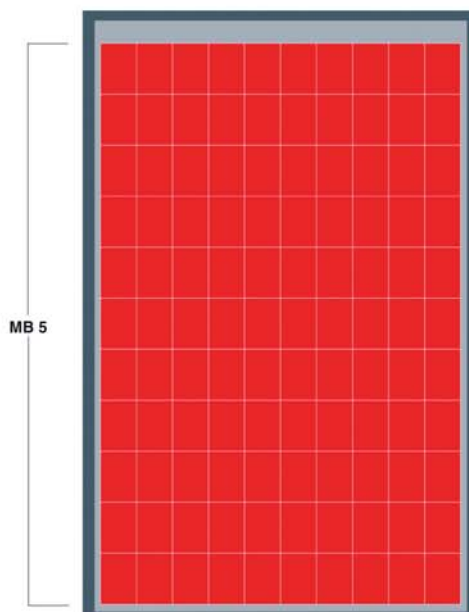

Fondo / Fund / Fond / Fondo / Boden



Pannelli / Panels /  
Panneaux / Paneles / Schiebewand

## SL 601A

Dotazione / Equipment /  
Dotation / Equipamiento /  
Dotation:

Fondo / Fund / Fond /  
Fondo / Boden:  
MB 5 n. 2 - MB 4 n. 16

Pannello / Panel / Panneau /  
Panel / Schiebewand :  
MB 6 n. 16

Totale numero cassetti /  
Total number of drawers /  
Numéro total des tirois /  
Número total de caiones /  
Anzahl Kippschubladen:  
n. 170

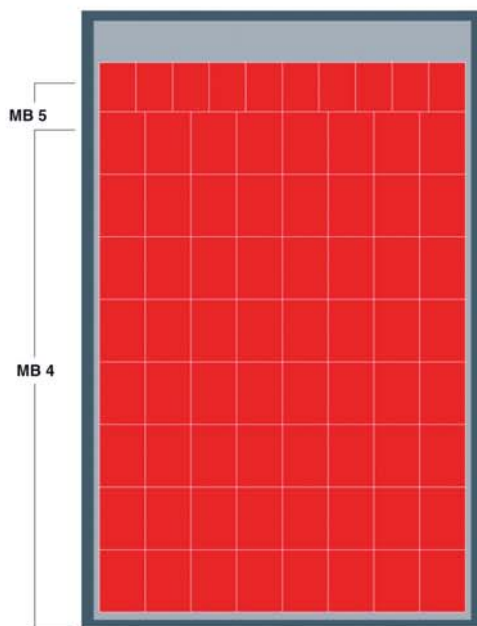

Fondo / Fund / Fond / Fondo / Boden

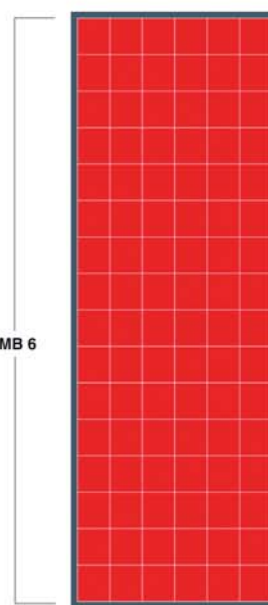

Pannelli / Panels /  
Panneaux / Paneles / Schiebewand

## SL 601 B

Dotazione / Equipment /  
Dotation / Equipamiento /  
Dotation:

Fondo / Fund / Fond /  
Fondo / Boden:  
MB 5 n. 2 - MB 3 n. 14

Pannello / Panel / Panneau /  
Panel / Schiebewand :  
MB 6 n. 16

Totale numero cassetti /  
Total number of drawers /  
Numéro total des tirois /  
Número total de caiones /  
Anzahl Kippschubladen:  
n. 148

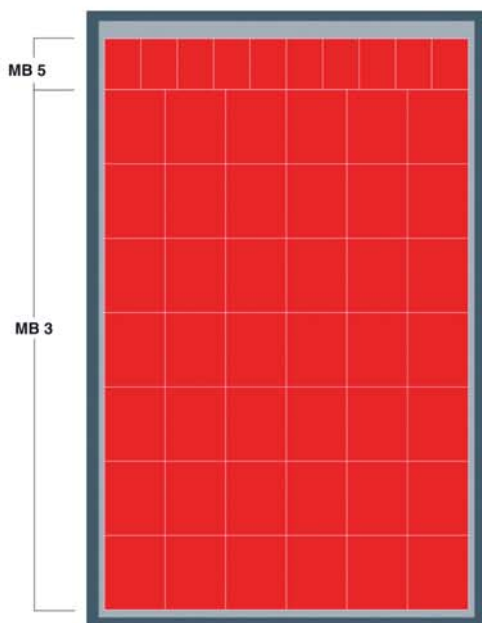

Fondo / Fund / Fond / Fondo / Boden



Pannelli / Panels /  
Panneaux / Paneles / Schiebewand



Armadi  
**SLIDE**

Armadi costruiti in lamiera elettrosaldata con barre di rinforzo e corredato di pannelli scorrevoli su cuscinetti a sfera, verniciato a forno con polvere epossidica di colore Grigio RAL 7035. Questo armadio è progettato in maniera tale da rendere agevole e veloce l'assemblaggio direttamente nel luogo di utilizzo. Il prodotto viene fornito smontato con schema di montaggio e viteria di assemblaggio.



Cabinets  
**SLIDE**

Cabinets made of electrowelded sheet and reinforcement bars, features panels sliding on roller bearings; RAL 7035 grey epoxy powder-painted. The cabinet has been designed in a way that facilitates the assembly on site. The product is supplied disassembled, with the installation schematic drawing and screws.



Armoires  
**SLIDE**

Armoires en tôle électrosoudée avec des barres de renforcement pourvue de panneaux coulissant sur des billes, laqués au four avec de la poudre époxydique couleur Gris RAL 7035. Cette armoire a été conçue pour faciliter et accélérer l'assemblage directement sur le lieu d'utilisation. Le produit démonté est livré avec le schéma de montage et les vis pour l'assemblage.



Armarios  
**SLIDE**

Armarios construido de chapa electrosoldada con barras de refuerzo equipado con paneles deslizantes sobre rodamientos de bola, pintado en horno con polvo epoxídico de color gris RAL 7035. Este armario se ha concebido de forma tal de volver fácil y rápido el ensamblado directamente en el lugar de uso. El producto se entrega desmontado con esquema de montaje y tornillos y tuercas de ensamblado.



Schränke  
**SLIDE**

Schränke aus elektrisch geschweißtem Blech mit Verstärkungsstreben, ausgerüstet mit Schiebewänden auf Kugellagern, mit Epoxidpulver einbrennlackiert, Farbe Grau RAL 7035. Dieser Schrank wurde eigens für eine praktische und schnelle Montage direkt am Verwendungsort entwickelt. Das Produkt wird zerlegt, mit Montageschema und Schraubenmaterial geliefert.

# SL 602



Armadio / Cabinet / Armoire / Armario / Schränk.

Imballo da pz / Package of pcs / Emballage de pcs / Embalaje un / Packung mit st: 1

Dimensioni / Dimensions / Dimensions / Dimensiones / Dimensionen:  
L 1270 mm - P 605 mm - H 1965 mm

Colore / Farben / Color / Couleur / Color: RAL 7035

Portata singolo pannello / Capacity of each panel / Portée de chaque panneau / Capacidad cada panel / Tragfähigkeit je schiebewand: Kg. 150

Fornito smontato / Supplied in kit form / Fournie démontée / Consignado desmontado / Wird zerlegt geliefert



# SL 602 STANDARD

Dotazione / Equipment / Dotation / Equipamiento / Dotation:

Fondo / Fund / Fond / Fondo / Boden: MB 5 n. 2 - MB 4 n. 16

Pannello 1 / Panel 1 / Panneau 1 / Panel 1 / Schiebewand 1: MB 5 n. 11

Pannello 2 / Panel 2 / Panneau 2 / Panel 2 / Schiebewand 2: MB 6 n. 16

Totale numero cassetti / Total number of drawers / Numéro total des tirois / Número total de caiones / Anzahl Kippschubladen: n. 225

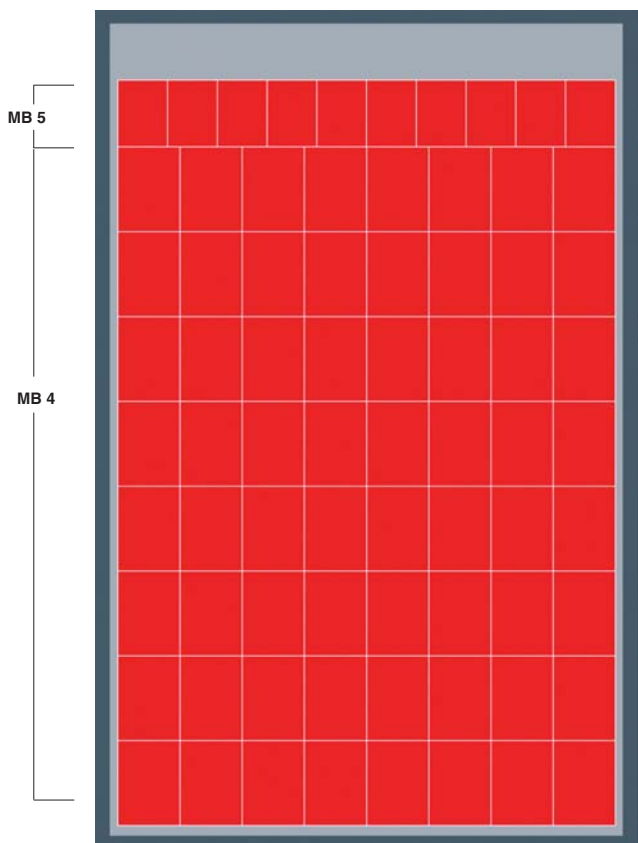

Fondo / Fund / Fond / Fondo / Boden

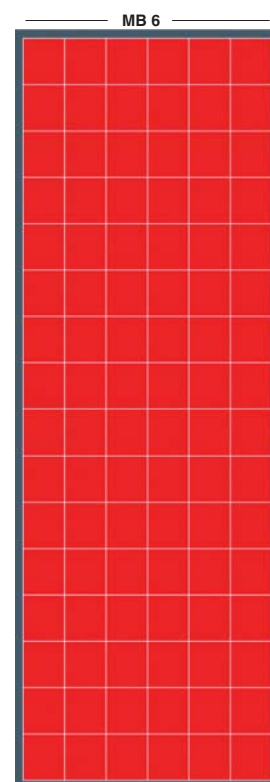
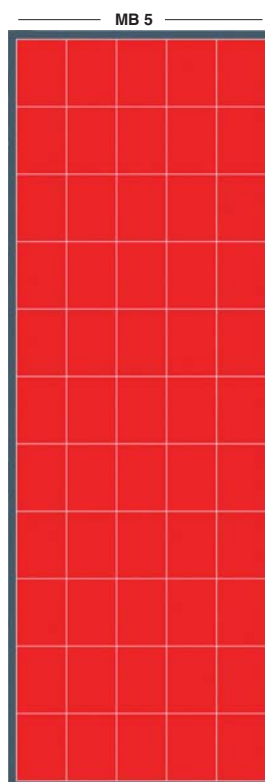

Pannelli / Panels / Panneaux / Paneles / Schiebewand

# SL 602 A

Dotazione / Equipment / Dotation / Equipamiento / Dotation:  
 Fondo / Fund / Fond / Fondo / Boden: MB 5 n. 2 - MB 3 n. 14  
 Pannello 1 / Panel 1 / Panneau 1 / Panel 1 /  
 Schiebewand 1: MB 5 n. 1 - MB4 n. 8  
 Pannello 2 / Panel 2 / Panneau 2 / Panel 2 / Schiebewand 2: MB 6 n. 16  
 Totale numero cassetti / Total number of drawers / Numéro total des tiroirs /  
 Número total de caiones / Anzahl Kippschubladen: n. 185

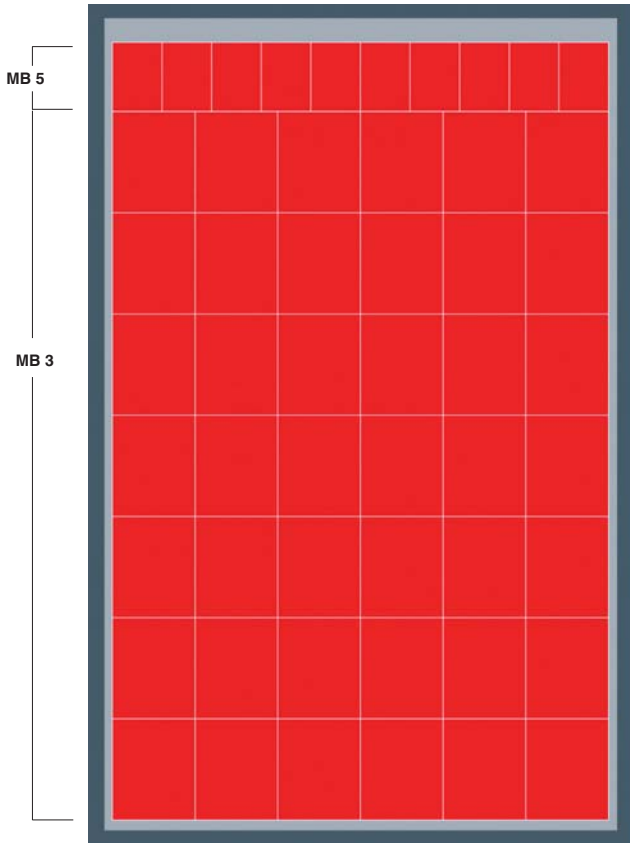

Fondo / Fund / Fond / Fondo / Boden

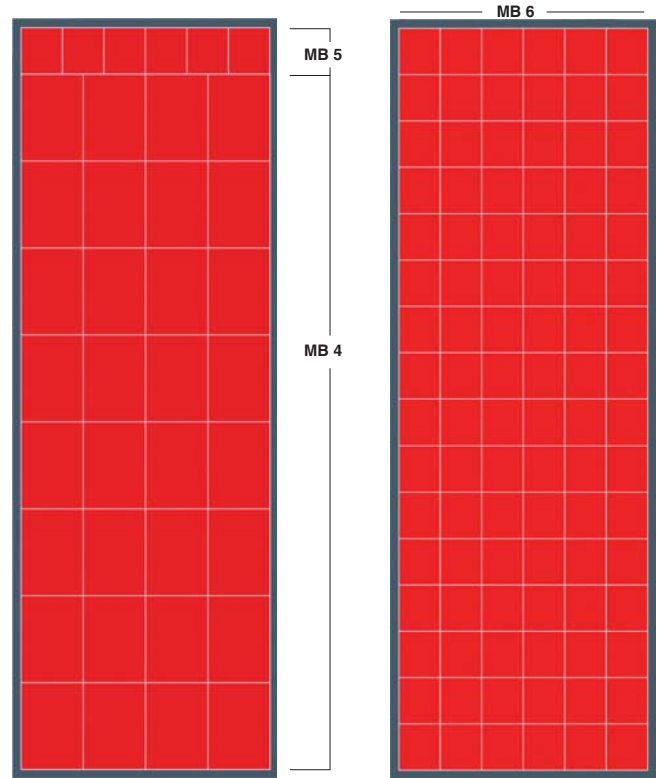

Pannelli / Panels / Panneaux / Paneles / Schiebewand

# SL 602 B

Dotazione / Equipment / Dotation / Equipamiento / Dotation:  
 Fondo / Fund / Fond / Fondo / Boden: MB 5 n. 22  
 Pannello 1 / Panel 1 / Panneau 1 / Panel 1 / Schiebewand 1: MB 6 n. 16  
 Pannello 2 / Panel 2 / Panneau 2 / Panel 2 / Schiebewand 2: MB 6 n. 16  
 Totale numero cassetti / Total number of drawers / Numéro total  
 des tiroirs / Número total de caiones / Anzahl Kippschubladen: n. 384

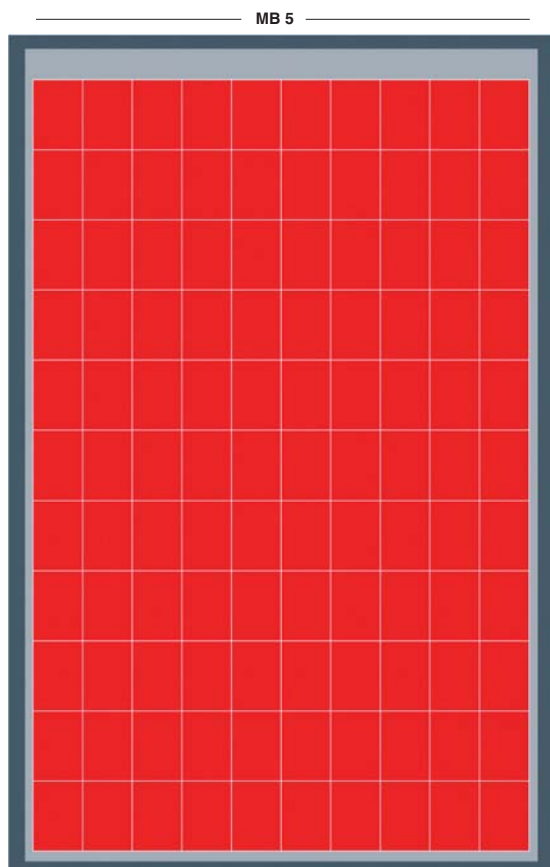

Fondo / Fund / Fond / Fondo / Boden

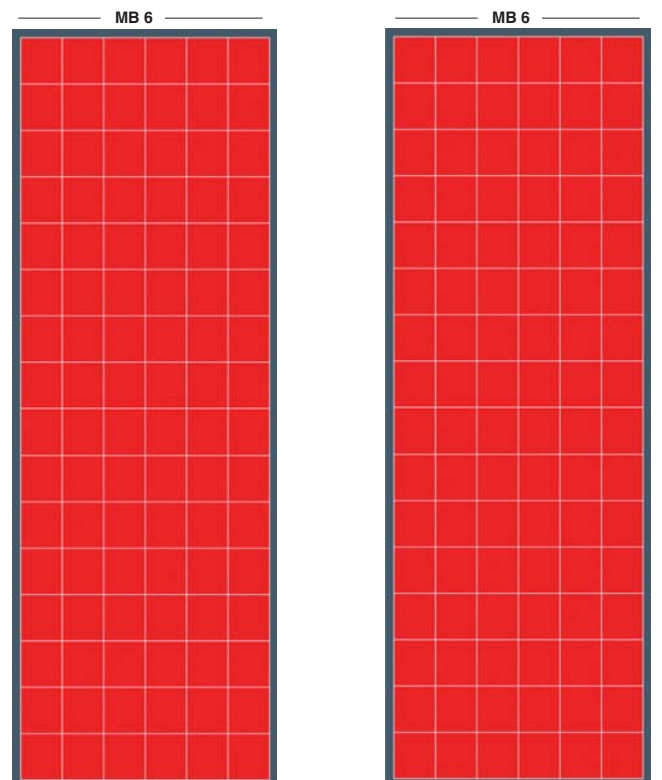

Pannelli / Panels / Panneaux / Paneles / Schiebewand

# SL 603



Armadio / Cabinet / Armoire / Armario / Schränk.

Imballo da pz. / Package of pcs / Emballage de pcs / Embalaje un / Packung mit st: 1

Dimensioni / Dimensions / Dimensions / Dimensiones / Dimensionen: L 1270 mm - P 605 mm - H 1965 mm

Colore / Farben / Color / Couleur / Color: RAL 7035

Portata singolo pannello / Capacity of each panel / Portée de chaque panneau / Capacidad cada panel / Tragfähigkeit je schiebewand: Kg. 150

Fornito smontato / Supplied in kit form / Fournie démontée / Consignado desmontado / Wird zerlegt geliefert



# SL 603 STANDARD

Dotazione / Equipment / Dotation / Equipamiento / Dotation:

Fondo / Fund / Fond / Fondo / Boden: MB 5 n. 22

Pannello 1 / Panel 1 / Panneau 1 / Panel 1 / Schiebewand 1: MB 6 n. 16

Pannello 2 / Panel 2 / Panneau 2 / Panel 2 / Schiebewand 2: MB 6 n. 16

Pannello 3 / Panel 3 / Panneau 3 / Panel 3 / Schiebewand 3: MB 6 n. 16

Totale numero cassetti / Total number of drawers / Numéro total des tiroirs / Número total de caiones / Anzahl Kippschubladen: n. 398

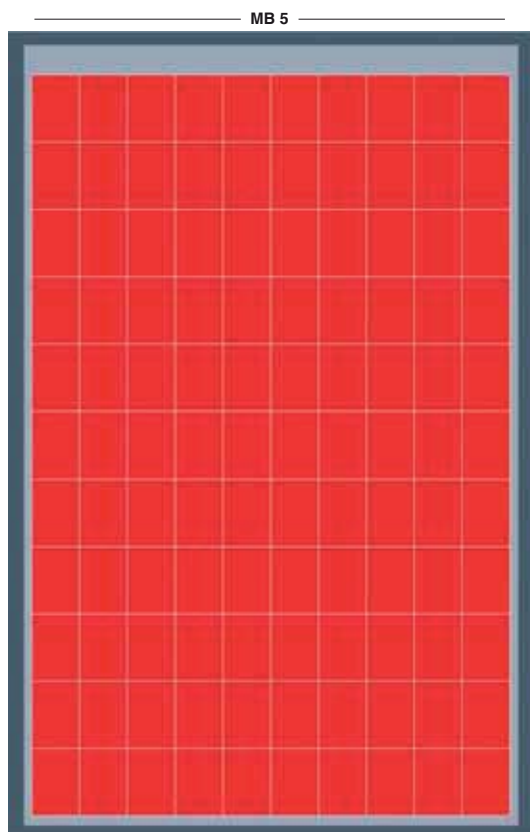

Fondo / Fund / Fond / Fondo / Boden

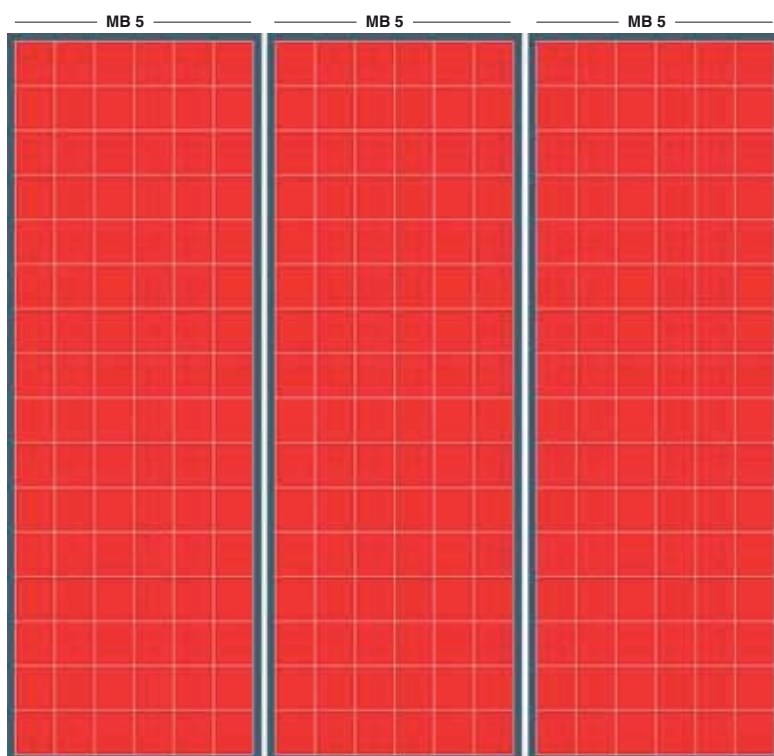

Pannelli / Panels / Panneaux / Paneles / Schiebewand

# SL 603 A

Dotazione / Equipment / Dotation / Equipamiento / Dotation:  
 Fondo / Fund / Fond / Fondo / Boden: MB 6 n. 32  
 Pannello 1 / Panel 1 / Panneau 1 / Panel 1 / Schiebewand 1: MB 6 n. 16  
 Pannello 2 / Panel 2 / Panneau 2 / Panel 2 / Schiebewand 2: MB 6 n. 16  
 Pannello 3 / Panel 3 / Panneau 3 / Panel 3 / Schiebewand 3: MB 6 n. 16  
 Totale numero cassetti / Total number of drawers / Numéro total des tiroirs /  
 Número total de caiones / Anzahl Kippschubladen: n. 480

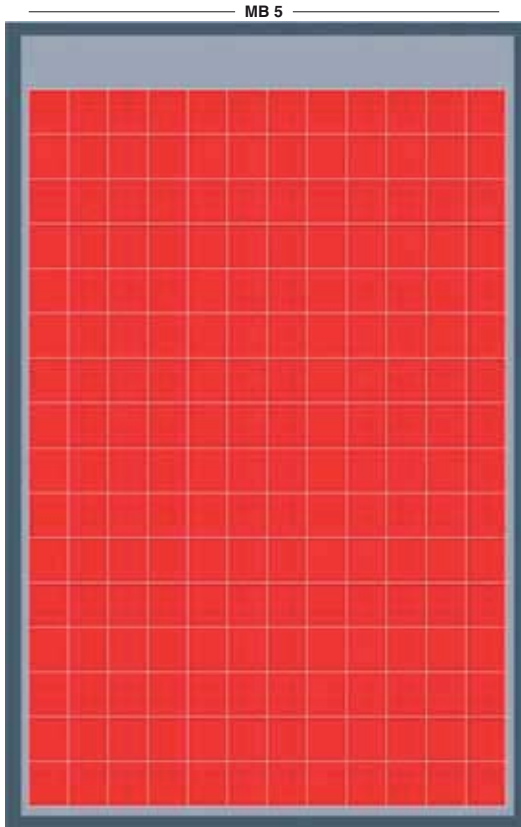

Fondo / Fund / Fond / Fondo / Boden

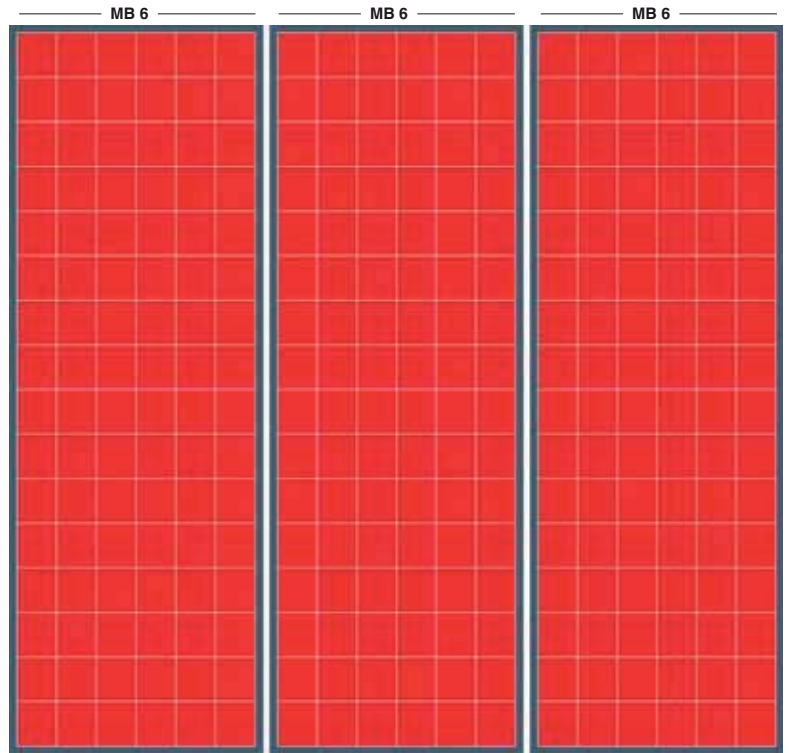

Pannelli / Panels / Panneaux / Paneles / Schiebewand

# SL 603 B

Dotazione / Equipment / Dotation / Equipamiento / Dotation:  
 Fondo / Fund / Fond / Fondo / Boden: MB 4 n. 16 - MB 5 n. 2  
 Pannello 1 / Panel 1 / Panneau 1 / Panel 1 / Schiebewand 1: MB 6 n. 16  
 Pannello 2 / Panel 2 / Panneau 2 / Panel 2 / Schiebewand 2: MB 6 n. 16  
 Pannello 3 / Panel 3 / Panneau 3 / Panel 3 / Schiebewand 3: MB 6 n. 16  
 Totale numero cassetti / Total number of drawers / Numéro total des tiroirs /  
 Número total de caiones / Anzahl Kippschubladen: n. 362

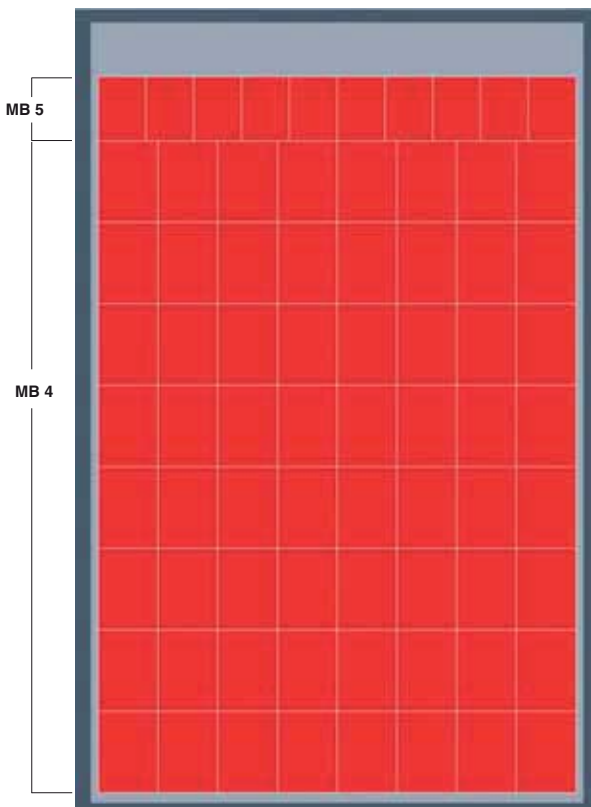

Fondo / Fund / Fond / Fondo / Boden

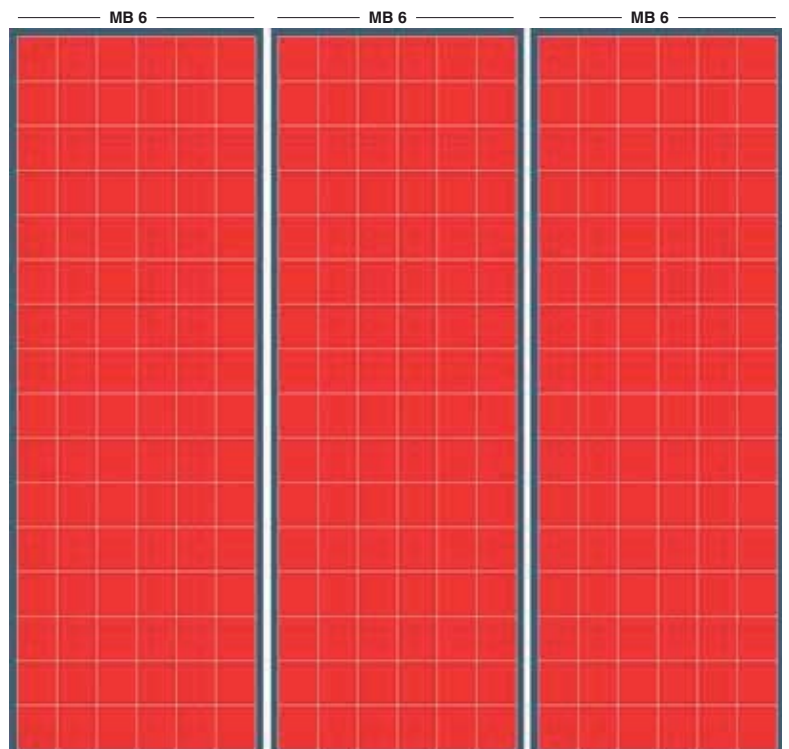

Pannelli / Panels / Panneaux / Paneles / Schiebewand



# TOOL BOXES

*Multi-purpose • Multi-usage • Milusos • Werkzeugträger*



## Portautensili **TOOL BOXES**

Organizer e portautensili realizzati in polipropilene, utili per riporre utensili e minuteria per un facile pronto impiego sia professionale che hobbistico.



## Toolboxes **TOOL BOXES**

Organizer and toolboxes made of polypropylene; recommended for tools, nuts and bolts, suitable for professional use and DIY.



## Porte-outils **TOOL BOXES**

Organizer et porte-outils réalisés en polypropylène, utiles pour ranger les outils, les petits ustensiles et faciliter une intervention rapide aussi bien pour les professionnels que les bricoleurs.



## Porta-herramientas **TOOL BOXES**

Organizer y porta-herramientas realizados de polipropileno, útiles para guardar herramientas y pequeño accesorios, para un uso fácil y rápido, tanto profesional, como para los aficionados.



## Werkzeugkästen **TOOL BOXES**

Organizer und Werkzeugkästen aus Polypropylen, geeignet zum Aufbewahren von Werkzeug und Kleinteilen für den einfachen und raschen Einsatz sowohl für den Profi als auch für den Heimwerker.



## TB 101

Organizer con separatori estraibili / Organizer with removable divisors / Organizer avec séparateur amovibles / Organizer con separadores extraíbles / Organizer mit bewegliche Trennwände.

Imballo da pz. / Package of pcs / Emballage de pcs / Embalaje un / Packung mit st: 20

Dimensioni / Dimensions / Dimensions / Dimensiones / Dimensionen:

L 230 mm - P 125 mm  
H 35 mm

Colore / Farben / Color / Couleur / Color: trasparente / transparent / transparent / transparente / durchsichtig.

## TB 103

Organizer con separatori estraibili / Organizer with removable divisors / Organizer avec séparateur amovibles / Organizer con separadores extraíbles / Organizer mit bewegliche Trennwände.

Imballo da pz. / Package of pcs / Emballage de pcs / Embalaje un / Packung mit st: 10

Dimensioni / Dimensions / Dimensions / Dimensiones / Dimensionen:

L 382 mm - P 234 mm  
H 48 mm

Colore / Farben / Color / Couleur / Color: trasparente / transparent / transparent / transparente / durchsichtig.

## TB 107

Organizer con compartimenti fissi / Organizer with fixed compartments / Organizer avec compartiments fixes / Organizer con compartimientos fijos / Organizer mit festen Fächern.

Imballo da pz. / Package of pcs / Emballage de pcs / Embalaje un / Packung mit st: 10

Dimensioni / Dimensions / Dimensions / Dimensiones / Dimensionen:

L 330 mm - P 250 mm  
H 53 mm

Colore / Farben / Color / Couleur / Color: Nero / Black / Noir / Negro / Schwarz

## TB 109

Organizer con separatori estraibili / Organizer with removable divisors / Organizer avec séparateur amovibles / Organizer con separadores extraíbles / Organizer mit bewegliche Trennwände.

Imballo da pz. / Package of pcs / Emballage de pcs / Embalaje un / Packung mit st: 8

Dimensioni / Dimensions / Dimensions / Dimensiones / Dimensionen:

L 510 mm - P 325 mm  
H 65 mm

Colore / Farben / Color / Couleur / Color: Nero / Black / Noir / Negro / Schwarz.

## TB 102

Organizer con separatori estraibili / Organizer with removable divisors / Organizer avec séparateur amovibles / Organizer con separadores extraíbles / Organizer mit bewegliche Trennwände.

Imballo da pz. / Package of pcs / Emballage de pcs / Embalaje un / Packung mit st: 20

Dimensioni / Dimensions / Dimensions / Dimensiones / Dimensionen:

L 292 mm - P 186 mm  
H 42 mm

Colore / Farben / Color / Couleur / Color: trasparente / transparent / transparent / transparente / durchsichtig.

## TB 106

Organizer con scomparti fissi / Organizer with fixed compartments / Organizer avec compartiments fixes / Organizer con compartimientos fijos / Organizer mit festen Fächern.

Imballo da pz. / Package of pcs / Emballage de pcs / Embalaje un / Packung mit st: 20

Dimensioni / Dimensions / Dimensions / Dimensiones / Dimensionen:

L 243 mm - P 180 mm - H 40 mm

Colore / Farben / Color / Couleur / Color: Nero / Black / Noir / Negro / Schwarz

## TB 108

Organizer con separatori estraibili / Organizer with removable divisors / Organizer avec séparateur amovibles / Organizer con separadores extraíbles / Organizer mit bewegliche Trennwände.

Imballo da pz. / Package of pcs / Emballage de pcs / Embalaje un / Packung mit st: 8

Dimensioni / Dimensions / Dimensions / Dimensiones / Dimensionen:

L 400 mm - P 305 mm  
H 62 mm

Colore / Farben / Color / Couleur / Color: Nero / Black / Noir / Negro / Schwarz.

## TB 110

Organizer con vaschette / Organizer with cups / Organizer avec godets / Organizer con vasitos / Organizer mit Wanneneinsätzen.

Imballo da pz. / Package of pcs / Emballage de pcs / Embalaje un / Packung mit st: 8

Dimensioni / Dimensions / Dimensions / Dimensiones / Dimensionen:

L 420 mm - P 350 mm  
H 60 mm

Colore / Farben / Color / Couleur / Color: Nero / Black / Noir / Negro / Schwarz.

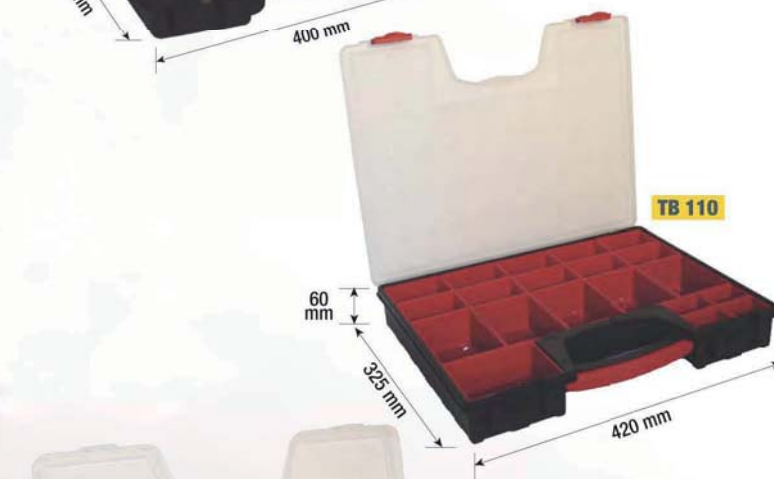
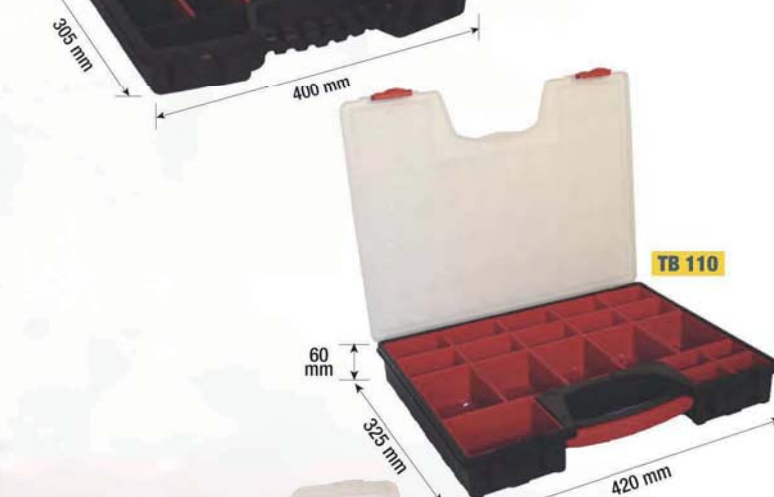
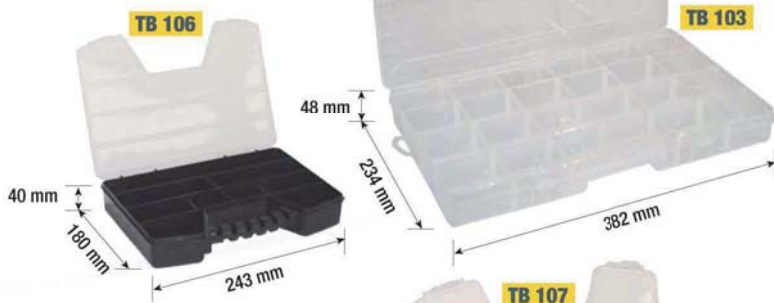
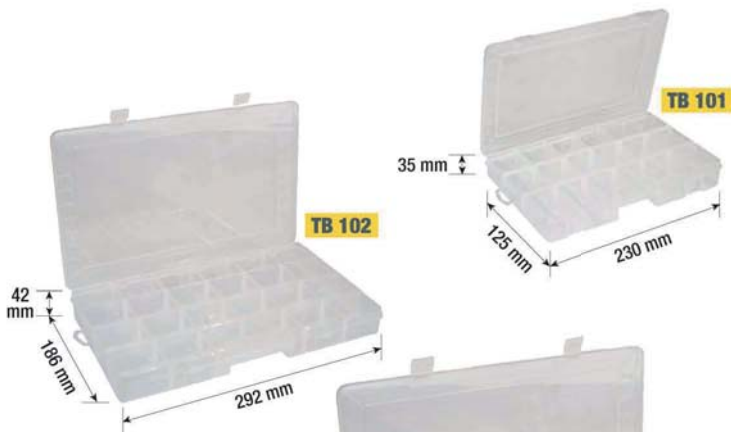



## SIMPLY SUPER - LO SCAFFALE BREVETTATO, SOLO AD INCASTRO, FACILE, PER IL FAI-DA-TE

SIMPLY SUPER e' un kit per il fai-da-te, ideato per un facile utilizzo in ambiente domestico. Si distingue per il suo design accattivante "hi-tech" oltre che per la sua robustezza e stabilit .

SIMPLY SUPER e' disponibile in due altezze diverse:

1840 mm con 5 ripiani oppure 1576 mm con 4 ripiani.

SIMPLY SUPER e' un sistema modulare: alle campate iniziali si possono aggiungere le estensioni da 900 mm, anche a pi  campate, tutte in profondit  400 mm.

I ripiani sono regolabili in altezza ad un passo minimo di 33 mm.



SIMPLY SUPER   realizzato in acciaio alto resistente, certificato 3.1B secondo le EN 10204.



## PLASTIC LINE - Informazioni generali / General Information / Allgemeine Informationen

Le misure indicate hanno una tolleranza di  $\pm 1-2$  mm.  
Die angegebenen Ma e gelten mit einer Toleranz von 1-2 mm.  
All dimensions have a tolerance  $\pm 1-2$  mm.  
Toutes dimensions indiqu es ont une approximation de  $\pm 1-2$  mm.  
Los tama os se alados son aproximativos por  $\pm 1-2$  mm.

I colori riprodotti hanno valore indicativo.  
Die Farben k nnen von den wiedergegebenen abweichen.  
The reproduced colours have indicative value.  
Tous coloris ont une valeur indicative.  
Todos los colores reproducidos tienen un valor solamente indicativo

###   possibile fornire per quantit  e prezzi da stabilire:

- prodotti in colori fuori catalogo
- prodotti in materiale autoestinguente a norma UL 94
- prodotti personalizzati.

### F r zu vereinbarende Mengen und zu festzulegenden Preisen k nnen:

- Produkte in nicht im Katalog angegebenen Farben
- Produkte aus selbstl schendem Material nach UL 94
- durch Stempelverfahren nach Wunsch bedruckte Produkte geliefert werden.

### It is possible to supply the following in individually arranged quantities and prices:

- Goods in colours not in catalogue
- Goods in self extinguishing materials conforming to the norms UL 94
- Personalized products.

### Nous pouvons fournir - sur demande - pour quantit s et prix   fixer:

- Produits standard en couleurs extra catalogue
- Produits en mat riel autoextinguible selon les normes UL 94
- Produits personnalis s.

### Es possible proveer por cantidad y precios de establecer los siguientes:

- Productos con colores extra standard
- Productos en material autoextinguente
- Productos con marca personal.

**N.B.:** I colori ed i modelli potranno subire variazioni senza preavviso.

**Bitte beachten Sie:** Wir behalten uns vor, Farben und Modelle ohne Vorank ndigung zu  ndern.

**N.B.:** Colours and models can be subjected to change without preadvice.

**N.B.:** Couleurs et mod les peuvent changer sans pr avis.

**N.B.:** Los colores y los modelos pueden ser variados sin preaviso.

Per impieghi diversi da quelli tradizionali si suggerisce di chiedere esplicite indicazioni. F r Anwendungen, die von den angegebenen abweichen, holen Sie bitte ausf hrliche Informationen ein.

For specific applications, different from those indicated in this brochure, please contact the company directly.

En cas d'usages pas standard veuillez demander d'indications explicites.

Por utilizaciones diferentes de las corrientes es aconsejado de preguntar indicaciones expl citas.



Prodotti in materiale riciclabile



Our dedication to making a difference: creating **MORE VALUE** with **LESS IMPACT!**  
**METALSISTEM** is proud to adopt **ECO-EFFICIENCY** concepts in its business model.  
**ZERO** emission and **ZERO** ecological impact thanks to a **UNIQUE MANUFACTURING PROCESS!**  
**METALSISTEM** has achieved energy self-sufficiency through the use of renewable resources.



more information here

PLASTIC line



MODULAR STORAGE SYSTEMS  
 MODULAR STORAGE SYSTEMS

**METALSISTEM**  
 SISTEMI E STRUTTURE PER IL MAGAZZINO

METALSISTEM S.p.A.  
 38068 Rovereto (Tn) - Viale dell'Industria, 2 - Italy  
 Tel. 0039 0464 303030 - Fax 0039 0464 303031  
 info@metalsistem.com - www.metalsistem.com

NR. EDIZIONE	01
DATA EDIZIONE	04/2005
NR. REVISIONE	03
DATA REVISIONE	04/2012
DATA STAMPA	04/2012